

# *The Frequency Generation*

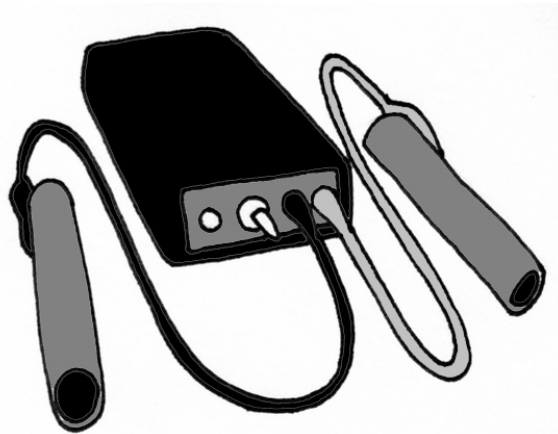


ClarkZapper.com



<http://creativecommons.org/licenses/by-nc-sa/3.0/>

Feel free to save a copy of this PDF book to your computer for future reference.



***Click on the Zapper Icons to return to the Table of Contents***

**[Page 3](#) -----What is a Zapper?**

**[Page 3](#) -----Quotes from Dr. Hulda Clark's Books**

**[Page 5](#) -----How To Zap**

**[Page 6](#) -----Zapper History**

**[Page 10](#) -----How To Build A Zapper**

**[Page 11](#) -----Setting Up A Plate Zapper**

**[Page 12](#) -----The Zappicator**

**[Page 15](#) -----Homeographic Bottle Copies**

**[Page 16](#) -----Scientific Studies on the Hulda Clark Zapper and Oscillating  
Electromagnetic Fields.**

**[Page 62](#) -----Scientific Studies on Hulda Clark's Herbal Parasite Cleanse**

**[Page 67](#) -----Other Free eBooks**

***The Zapper Disclaimer:***

*The Hulda Clark Zapper has not been licensed by the US Food and Drug Administration as a medical device for use in the cure, mitigation, treatment, or prevention of any disease. The Hulda Clark Zapper can only be sold as an experimental device. You have the right to experiment with a Hulda Clark Zapper, but do so at your own risk. If you are pregnant or wearing an electronic pacemaker, please do not experiment with a Hulda Clark Zapper. All information is for educational purposes only. Consult a licensed health professional before attempting any self health program. For free information on how to build and use a Hulda Clark Zapper visit: [HuldaClark.com/media.html](http://HuldaClark.com/media.html)*

# What is a Zapper?

Hulda Clark invented the Hulda Clark Zapper, and published the instructions to build a zapper in all of her books. Dr. Clark defines a zapper as any 9 volt battery operated analog frequency generator with a 1/4 volt *Positive Offset* square wave output between 10 Hertz - 500,000 Hertz with a 50% Duty Cycle using two 4-inch long 3/4 inch Copper Pipe Handles as electrodes.

*Positive Offset* means that when the square wave is tested on an oscilloscope the wave form is 100% positive. The square wave should be at least 1/4 volt above zero at its lowest point. The wave form should never cross into negative. It is the Positive Offset of the square wave that is the function of the zapper. Any negative output or negative spikes must be avoided. Frequency and duty cycle are not nearly as important as the 1/4 volt Positive Offset of the output.

## Quotes from Dr. Hulda Clark's Books:

*These quotes are not intended to make any medical claims for the zapper. They are simply quotes defining the zapper as described in Dr. Hulda Clark's books.*

"By zapping I mean selectively electrocuting pathogens. For years I used a commercial frequency generator to 'zap' one pathogen after another.

First I made a chart of the frequencies for most of the bacteria and viruses in my collection (over 80, see page 561, [The Cure For All Diseases](#)). Then I would test the sick client for each one of these, and hope they did not have one for which I didn't have a sample. Even persons with a simple cold typically had a dozen they tested positive to (not just Adenovirus).

Next it was time to tune in the frequency generator to a dozen frequencies for three minutes each. The total process, testing and treatment, would take about two hours. They frequently got immediate relief. But often the relief would be temporary. What I didn't know at that time was that viruses could infect a larger parasite such as a roundworm. Until you killed your roundworm and your virus, you would keep getting the virus back promptly.

In 1993 my son, Geoffrey, joined me and we tried a new approach. He programmed a computer controlled frequency generator to automatically cover all the frequencies populated by all the parasites, viruses, and bacteria, from 290,000 Hz to 470,000 Hz. It spent about three minutes for every 1000 Hz it covered. This was more efficient, but it meant spending ten hours being zapped.

Again, the results were disappointing. Arthritis pain, eye pain, colds were improved, but not completely cured overnight. Months later I would find that organisms were transmitting as low as 170,000 Hz, and as high as 690,000 Hz.

My specimen collection was obviously incomplete. To cover this larger range, spending three minutes for every 1000 Hz, would take 26 hours. Still worth doing if it would indeed help all our illnesses. But even this method of zapping was not 100% effective for reasons yet to become clear.

In 1994 my son built a hand held, battery operated, accurate frequency generator. The purpose was to enable everyone to kill the intestinal fluke at 434,000 Hz with a low cost device. Enough benefit would be derived from zapping at various frequencies that I thought everyone should know how to make one. When I tested it on one of my own bacteria, however, three others at much different frequencies died also! This had never happened before. When I tested it on others, even though they had dozens of pathogens, all were killed!

Subsequent testing showed it was not due to some unique design, or special wave form produced by the device. It was due to battery operation!

Any positively offset frequency kills all bacteria, viruses and parasites simultaneously given sufficient voltage (5 to 10 volts), duration (seven minutes), and frequency (anything from 10 Hz to 500,000 Hz)."

**Page 13-15: [The Cure For All Diseases](#) © by Hulda Regehr Clark Ph.D., N.D. 1995**

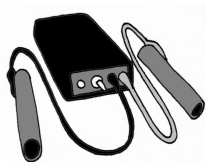
"Being able to kill your bacteria and other invaders with electricity becomes much more of a panacea when you can do it all in three 7 minute sessions. No need to single out specific frequencies or to sweep through a range of frequencies one kHz at a time. No matter what frequency it is set at (within reason), it kills large and small invaders: flukes, roundworms, mites, bacteria, viruses and fungi. It kills them all at once, in 7 minutes, even at 5 volts."

**Page 19: [The Cure For All Diseases](#) © by Hulda Regehr Clark Ph.D., N.D. 1995**

"Even very brief 'Negative spikes' are undesirable. For this reason the circuit given here has an additional component, a Positive offset resistor. With this addition, it is easy for the builder to measure the Positive offset on an oscilloscope. It will be 1/4 volt."

"Although wrist straps are convenient, not enough research has been done to accurately compare effectiveness with the tubular design of electrodes... A person should use the copper tube electrodes, of correct dimension, correctly placed, and not risk poor conductance."

**Two excerpts from page 478: [The Prevention Of All Cancers](#) © by Hulda Regehr Clark Ph.D., N.D. (Dr. Clark's 2004 Zapper Circuit update).**



# How To Zap

Wrap each copper handle in one layer of damp paper towel. If your zapper has a 1 kHz and 30 kHz switch, set the zapper output to 30 kHz. Zap for three 7 minute sessions with a 20 minute break in between.

## *ZAPPING TIPS:*

To complete a full round of zapping takes about an hour. Up to four people can zap together, simply pass the zapper on to the next person after each 7 minutes.

When you first start zapping, zap once a day for about a month. After that, zap once a week or as needed.

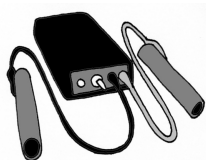
When holding the handles and zapping, don't put your hands together. Electricity will follow the shortest path and the current will not flow through the rest of your body. Keep your hands relaxed and to your sides.

Dr. Clark states in her books that the zapper current does not reach any part of the body that is shielded from electricity. Parts of the large intestine, and the hollow center of the eye are examples. The beneficial flora found in the large intestine are not zapped because of this.

Dr. Clark suggests taking her *Herbal Parasite Cleanse* of Black Walnut Hull, Wormwood, and Cloves along with zapping. The 18 day herbal cleanse is slower, but reaches the entire body. The zapper is fast, but electricity cannot reach shielded areas. Visit: [HuldaClark.com](http://HuldaClark.com) for more info.

When zapping and cleansing one may experience what is called a Herxheimer Reaction. If you feel exhausted, or feel cold symptoms after zapping, it could be from the body having to remove all the dead bacteria and parasites. It is suggested to keep on with the program for best results, but use your own intuition and common sense. If you have any medical concerns, consult a licensed health practitioner. For more information on this topic do a Google Search on the keywords: [Herxheimer Reaction](#).

Extended Zapping: More is better! Zap for longer sessions than 7 minutes. After you have used the zapper for a while try zapping for 20 minute sessions with 20 minute breaks in between. Zap any time you feel minor pain or a cold coming on. Bacteria cause a lot of our aches and pains. The only way to know if zapping will relieve it is to zap and find out. We are all mad scientists, and life is one long experiment! Be sure to see a licensed medical professional if you have a major illness.



# Zapper History



***Davis and Kidders Patent Magneto Electric Machine 1854***

There is a long history of Frequency Oscillations being used in research that has inspired and led up to Dr. Hulda Clark's published experiments. The idea that frequency devices could destroy pathogens like a singer breaking a glass has been tested in the laboratory for over 150 years with amazing results. Since all things alive and inanimate have a unique frequency that will destroy them, many scientists have wanted to eradicate germs, bacteria, and viruses using *Mortal Oscillatory Rates*. We call the scientists and the people who benefit from their findings *The Frequency Generation*. Here are a few examples of the leading Pioneers of Frequency Healing Research:

**Nikola Tesla** in the early 1900's developed a science called *Diathermy*. Here is a quote by Tesla: "One of the earliest observations I made with these new machines was that electrical oscillations of an extremely high rate act in an extraordinary manner upon the human organism. These oscillations produced other specific physiological effects, which, upon my announcement, were eagerly taken up by skilled physicians and further investigated. This new field has proved itself fruitful beyond expectation, and in the few years which have passed since, it

has been developed to such an extent that it now forms a legitimate and important department of medical science."

**Royal Raymond Rife** developed frequency devices intended to destroy pathogens in living beings. Rife built special microscopes and frequency devices and charted which frequency destroyed which microbe, bacteria, and virus. Rife coined the term *Mortal Oscillatory Rate* and charted the specific frequencies that destroyed pathogens. When given the chance to demonstrate his devices, Rife was recorded as curing all of the cancer patients in his study using his experimental frequency instruments. There is a great book by Barry Lynes titled: [\*The Cancer Cure That Worked, 50 Years of Suppression\*](#). Order it on Amazon, and read this amazing book about Rife and his research on therapeutic frequency devices during the 1930's.

**Georges Lakhovsky**, with help from Nikola Tesla, invented the *Multi Wave Oscillator*, which was claimed to revitalize the health of cells. His book, [\*The Secret of Life\*](#) documents his 98% success rate working with cancer patients in the 1930's-1940's. In 1942 Lakhovsky traveled to New York City to visit his friend Tesla and was hit by a mysterious black limousine. The passengers brought him to the hospital (against his will - he claimed he was not hurt), and Lakhovsky, age 72, died in the hospital three days later. World War II broke out, and the Multi Wave Oscillator was removed from hospitals by order of the AMA.

**Bob Beck** developed a "blood zapper" that when combined with a very strict diet is claimed to rid the blood of many pathogens. Based on the research at Albert Einstein College by Dr. Steven Kaali and their announced and patented cure for AIDS: US Patent #5188738.

**Hulda Clark** published the first schematic for building a 30,000 Hertz Zapper in her book, [\*The Cure For All Cancers\*](#) in 1993. Later in her 2004 book, [\*The Prevention Of All Cancers\*](#) Dr. Clark updated the zapper schematic to be a minimum 1/4 volt Positive Offset to make the device even more effective. Along with this update, Dr. Clark published the build instructions for making a Zappicator, which is a low frequency 1000 Hertz zapper that sends the frequency signal through a North Pole Speaker instead of copper handles. The Zappicator allows one to zap items that cannot hold handles, such as food, water, and pets. Using a Zappicator is a bit more complicated because one must remove all metal from the item or person being zapped. Metal interferes with the polarity of the signal coming from the speaker's magnet. Before using the 1000 Hz Zappicator, food items in cans must be put into plastic, glass, or ceramic. Pets must have collars and tags removed. People must remove clothing with metal zippers, rivets, keys, jewelry, or coins. The original 30,000 Hz Zapper and 1000 Hz Zappicator are the only two zapper schematics ever published by Dr. Hulda Clark.

**Robert Becker** is the leading expert in studying electrical stimulation for regenerating limbs. Dr. Becker has studied the salamander's ability to regenerate

a lost limb. Becker believes that since humans generate limbs in the womb, that it is possible to stimulate and recreate the same ability when an adult has lost a finger, arm, leg and so on. Dr. Robert Becker's book, [\*The Body Electric\*](#) records his exciting research in the area of electrical stimulation for human limb regeneration.

**TENS** is a frequency device that is registered as a medical device here in the US. It is often used to help block pain signals after a major injury. Once in a while you will see a football player on TV hooked up to a TENS unit after an injury to help with his rehabilitation. TENS devices are sold in the US by prescription only.

**The US FDA** did an interesting study: [\*Kinetics of Microbial Inactivation for Alternative Food Processing Technologies - Oscillating Magnetic Fields\*](#). This and many other studies are included below in the *Scientific Studies* chapter found at the end of this PDF book. See especially the chart of pathogens destroyed, a very convincing FDA study. It is exciting that the FDA has begun conducting this kind of frequency based research.

### **Several US Patents exist that are of interest:**

**US Patent # 5188738:** *Alternating current supplied electrically conductive method and system for treatment of blood and/or other body fluids and/or synthetic fluids with electric forces.*

**US Patent # 4524079:** *Deactivation of microorganisms by an oscillating magnetic field.*

**US Patent # 4665898:** *Malignancy treatment using pulsed magnetic fields.*

**US Patent # 6409719:** *Light stent implant device for treatment of long term viral infection.* Electromagnetic radiative energy including visible, and optionally, thermal, RF and/or microwave wavelengths, is topically applied to internal surfaces of the upper respiratory tract to destroy or incapacitate superficial microorganisms without the use of antibiotics.

**University of Washington** has done several Hulda Clark related studies of interest. A recent press release states: [\*Magnetic fields may hold key to malaria treatment\*](#). And an incredible study on: [\*Low-intensity electric current-induced effects on human lymphocytes and leukemia cells\*](#) was done using a Hulda Clark Zapper. The same researchers did a study on some of the ingredients used in [\*Dr. Clark's Herbal Parasite Cleanse\*](#). Be sure to take the time to check out the details of these amazing studies found at the end of this PDF book.

**[\*New Way to Kill Viruses: Shake Them to Death\*](#)** "The capsid of a virus is something like the shell of a turtle," said physicist Otto Sankey of Arizona State University. "If the shell can be compromised [by mechanical vibrations], the virus can be inactivated."

**[\*Disruption of Cancer Cell Replication by Alternating Electric Fields\*](#)**, "The highly specific effects of these fields on dividing cells, together with the relative

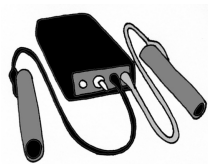


ease of applying them, focusing them, and screening from them, make them an attractive candidate to serve as a novel treatment modality for cancer."

***Discovery of Tumor-Specific Frequencies*** "Because in vitro studies suggest that low levels of electromagnetic fields may modify cancer cell growth, we hypothesized that systemic delivery of a combination of tumor-specific frequencies may have a therapeutic effect." Cabinet Medical, Avenue de la Gare 6, Lausanne, Switzerland.

***Frequency Specific Microcurrent*** "The treatment is called FSM, or frequency specific micro-current. During the procedure, tiny electrodes are attached to the injured area. These electrodes deliver a tiny, imperceptible electrical current (just millionths of an amp). This current is at the same frequency as what the body's cells normally produce. So it causes those cells to resonate. This increases cellular activity, which in turn increases the energy produced by the cells. In fact, one study found that cells increase their production of ATP (the energy molecule) by a whopping 500%! That's five times the energy! But that's not all. Research shows that FSM increases the rate of protein synthesis by 70%. In other words, it helps re-build damaged tissue. Let me say that again. FSM helps re-build the parts of your body, whether it's tendons, ligaments, or organs." Robert J. Rowen, MD

***Olympians Use 'Secret Device' for Improved Flexibility***. Research by Dr. Bill Sands, leader of the Recovery Center for the United States Olympic Committee had shown that resting a limb on a vibrating surface during stretching greatly increased the flexibility of that limb. The machine itself is surprisingly simple. It's shaped like a small pommel horse and shakes continuously at 30 hertz. After trials with young male gymnasts showed 400% improvements acutely and significant increases at four weeks, Sands felt the device was ready for Olympic prime time. Three years later, with a series of peer-reviewed publications, Sands says the effect of the machine is indisputable. Sands says it's one of the best devices they have. "We don't have a lot of silver bullets, but this is one of them." The runaway success of the U.S. flexibility device came from scouring old medical journals. Sands' team found a reference in a 1974 journal, written by an Israeli researcher, about a device some Russians had used to improve flexibility. Sands had a model built and with some experimentation, came up with a copy. The device worked so well — with permanent results — that Sands and others have wondered how many other simple fixes might be out there. Few in the USA are doing the research.

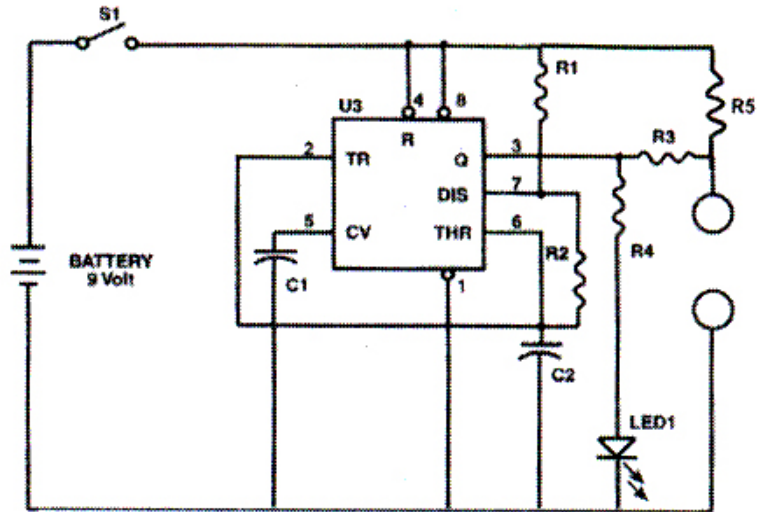


# How To Build A Zapper

## ClarkZapper.net

30kHz Hulda Clark Zapper Parts List:

- R1 - 1K
- R2 - 4.7K
- R3 - 1K
- R4 - 2.2K
- R5 - 39K
- C1 - .0047 uF
- C2 - .0047 uF
- U3 - MC 1455
- LED - 3 ma LED red



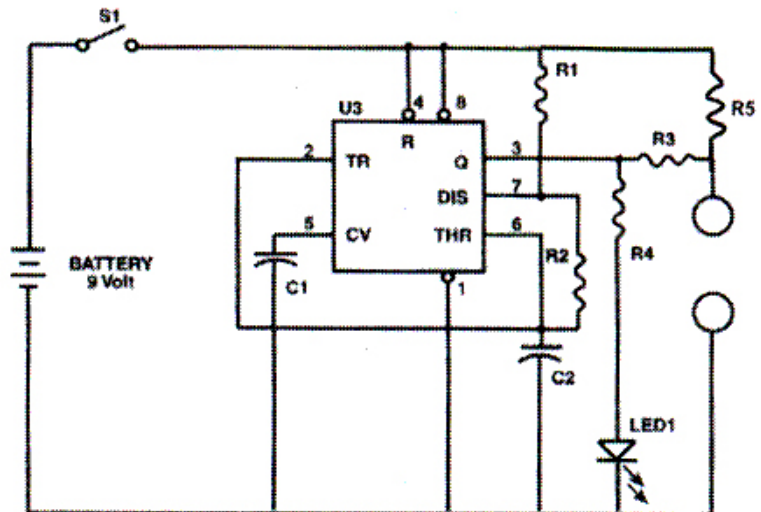
Hulda Clark has published several different ways to build a zapper. In her first books she published a schematic and build instructions that involved lots of lead wires to connect everything, or soldering ability for a better build. In later books she employed the use of an electronic breadboard that allows one to simply plug in the electronic parts into the grid on the breadboard making the build simple enough for a child to complete.

The parts list was changed for the breadboard zapper to make switching from the original 30 kHz Zapper circuit to the low frequency 1 kHz Zappicator circuit by simply changing the R2 resistor in the schematic. This way one could easily have both frequencies published by Dr. Hulda Clark in one unit.

## ClarkZapper.net

1000Hz Hulda Clark Zapper Parts List:

- R1 - 1K
- R2 - 144K (hard to find use two 270K)
- R3 - 1K
- R4 - 2.2K
- R5 - 39K
- C1 - .0047 uF
- C2 - .0047 uF
- U3 - MC 1455
- LED - 3 ma LED red



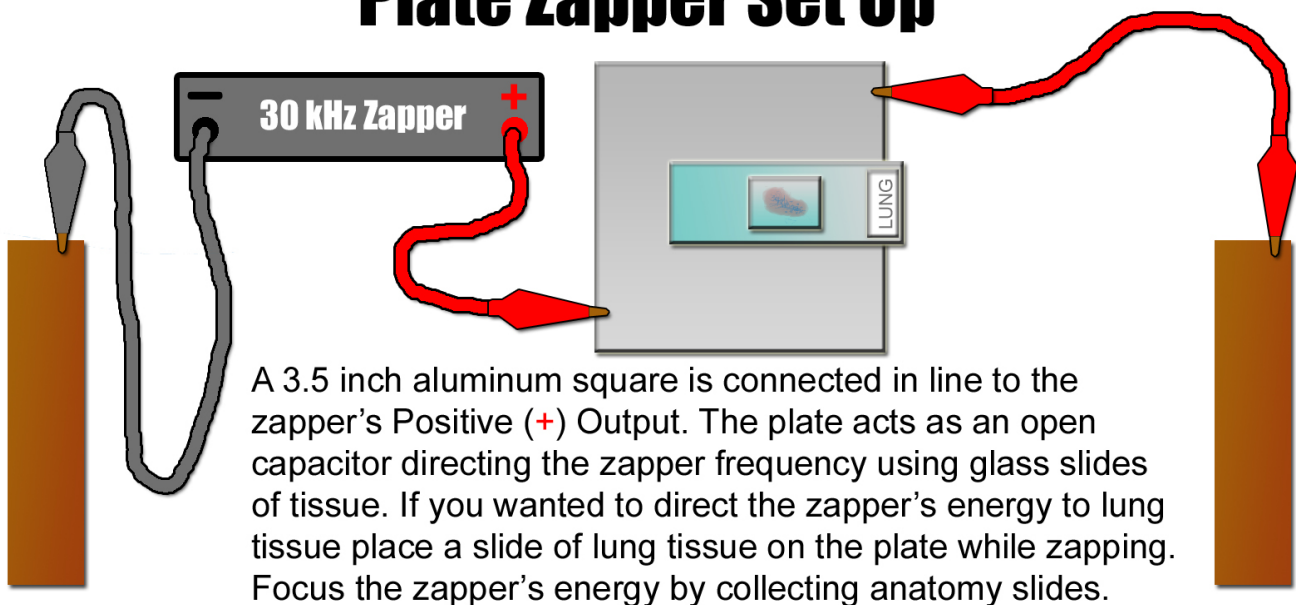
For a free step by step instruction video on how to build a Hulda Clark Zapper visit: [www.ClarkZapper.NET](http://www.ClarkZapper.NET)

# Setting Up A Plate Zapper

Hulda Clark published several advanced zapping techniques that require more complicated set ups, but offer even more features than regular zapping. Alternative Health Practitioners, Electronic Hobbyists, and Home Mad Scientists will all enjoy experimenting with these interesting advanced zapping techniques.

The Hulda Clark Zapper works a lot like a radio emitting *Radio Frequency*. The RF frequency can be tuned and directed to any part of the anatomy by setting up a Plate Zapper. By connecting one or two 3.5 inch aluminum squares in line with the Zapper's Positive (+) Output, the square plate acts as an *open capacitor* allowing the user to "tune in" on where the Zapper sends its signal. It just needs to know where you want it to go. By using scientific glass slides with anatomy samples placed on the plate, the signal will find the matching area and focus the Zapper's power. For instance if you wanted to zap the lungs, simply place a slide of lung tissue on the plate while zapping. By collecting a whole set of anatomy slides one could easily zap any part of the body more effectively. Order sets of anatomy slides at [Wards Science](#) or [Carolina Science Supply](#).

## Plate Zapper Set Up



Hulda Clark explains in her books that every organ of the body has a unique frequency. By using glass slides of anatomy, the frequency finds the unique match and directs the zapper's energy to the same tissue as what is placed on the Zap Plate. It's like tuning in on your favorite radio station's frequency. Read Dr. Clark's books: *The Prevention Of All Cancers* and *The Syncrometer Science Lab Manual* for many of Dr. Clark's published experiments using Plate Zapper technology.

**For more information on setting up a Plate Zapper visit: [PlateZapper.com](http://PlateZapper.com)**

# The Zappicator

In 2003 -2004 Dr. Hulda Clark published the instructions for building a device called a *Zappicator*. A Zappicator allows one to zap anything and anyone who cannot hold handles, such as food, water, pets, and people. The Zappicator involves a low frequency 1000 Hertz Zapper that sends the frequency through a North Pole Speaker instead of copper handles.



North Pole Speaker



The N on a compass is attracted to the face of a North Pole Speaker.

2 inches (50 mm)  
8 ohm



- +  
www.PositiveOffset.com  
Electronic Parts and Zapper Kits

What is a North Pole Speaker? Any 8 Ohm 1/4 Watt 2" to 2 1/2" speaker with a paper face that attracts the N on a compass is a North Pole Speaker.

The North Pole Speaker's + tab is connected to the Positive (red) output of a 1 kHz Zapper to create a Food Zappicator. Ground is NOT used. RF

frequency does not need a complete circuit to operate. In this way, the speaker's magnet acts like a radio antenna sending the zapper signal. Contain the speaker in a nonmetal plastic enclosure or cardboard box because metal interferes with polarity. Complete details are found in Dr. Clark's [HIV](#) and [Prevention](#) books.

The Zappicator consists of two parts. A low frequency 1000 Hertz Zapper powers a North Pole Speaker mounted inside a nonmetal box. The Zappicator allows one to zap items that cannot hold handles like food, water, pets, and people. The North Pole Speaker broadcasts the frequency from the 1000 Hertz Zapper like a little radio station. The North Pole Speaker must be contained inside a *nonmetal* box made of plastic, wood, or cardboard. Metal interferes with polarity. Hot glue speaker into place. Plates of food or jugs of water in *nonmetal containers* like plastic, glass, or ceramic can be placed on top of the North Pole Speaker Box to make Zapping food easy.

1000 Hertz Zapper +

North Pole Speaker

The 1000 Hz Zapper is connected by the Positive (+) output to the (+) on the speaker. The ground (-) is not connected. More build information at: [www.ClarkZapper.NET](http://www.ClarkZapper.NET)

Set food or water on top of the speaker box so North side of speaker is directly under facing up. Zappicate items for 10-20 minutes on top of the speaker box in nonmetal containers. If food is in a can, put it into a plastic, glass, or ceramic container. Be sure to remove all metal caps on glass containers.



To test the North Pole Speaker in Your Food Zappicator, hold the speaker box upright on it's end. Then hold a compass near the center. The N on a compass should be attracted to the top of the speaker box as seen below.

[www.ClarkZapper.com](http://www.ClarkZapper.com)



When zappicating pets, remove all collars and tags. Do not use Zappicator on a metal surface or in a metal kennel. Ask people to remove clothing with metal zippers, rivets, buttons, jewelry, keys, and coins. Test the Speaker Box before each use with a compass. Tilt speaker box on its side, hold compass near top, and the N should be attracted toward the top of the speaker box. Because magnets can change polarity, it is best to test the unit before each use with a compass.

Above the North Pole Speaker is hot glued inside a common Rubbermaid Home 2916-RD-WHT Drawer Organizer Tray. Food, water, and pets are easily placed on top and zapped at 1000 Hz. Zappicate pets for 3 minutes, and work up to a full 20 minute session.

Why avoid metal when Zappicating? Magnets instantly turn ferrous metal to the *opposite polarity*. If you put the north side of a magnet on your refrigerator, it

sticks. If you turn the magnet around, the south side sticks as well. Metal on top or under the speaker box will turn the North polarity to South interfering with the process. Even nonferrous metals create strange reactions, so avoid all metal on top or under when using a Zappicator.

Remove all metal collars & tags.  
Do not use inside metal kennel.  
Start slow: 3 minutes a day  
then Zap 20 minutes or more.  
Not a medical device - for  
experimental use only.



1 kHz  
Zapper

North Pole Speaker Box

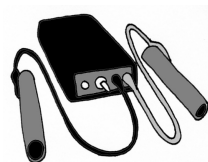
# Hulda Clark Pet Zappicator

PositiveOffset.com

Dr. Clark also published a design for a Toothbrush Zappicator, used for getting into hard to reach areas like teeth. Use a compass and find an ear bud speaker that attracts the N of a compass to the speaker's face. Cut the speaker's wires and connect the red Positive (+) wire to the 1000 Hz Zapper's Positive (+) output. Cover Toothbrush Zappicator with a plastic baggie so unit does not get wet inside your mouth. Do not use a Toothbrush Zappicator on teeth with metal fillings.



For free instruction videos on how to *build and test* a Zappicator visit: [www.ClarkZapper.net](http://www.ClarkZapper.net)



# Homeographic Bottle Copies



## Bottle Copies Homeographic Drops



Another use for the Zap Plate and a 30 kHz Zapper is to imprint water which Hulda Clark called *Homeographic Bottle Copies*. The Zapper is connected to the plate using only the Positive (+) output. Ground (-) is not used.

Hulda Clark published many experiments in the book, [\*The Prevention Of All Cancers\*](#) based on imprinting water with frequencies for various experiments. Hulda Clark's chapter on *Homeography* starts on page 105. Dr. Clark states that water will hold any frequency it is exposed to.

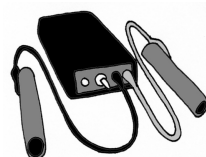
One can place a 1/2 ounce amber glass bottle of distilled water touching any substance on the plate, zap for 20 seconds and the water will now carry the same frequency as the substance it was touching on the plate. Tissue slides, bones, chemicals, and more can all have their frequency copied into water this way.

Hulda Clark suggests to test and verify each Bottle Copy using a Syncrometer as described in her book, [\*The Syncrometer Science Lab Manual\*](#).

Dr. Clark used Homeographic Bottle Copies to strengthen organs. The theory is that stress and illness takes our body's healthy frequencies out of balance. The Bottle Copy will remind the body of the proper healthy frequency, and help restore the proper frequency by taking Homeographic Drops.

Hulda Clark states: "Zapping an organ while taking drops for that same organ seems to be especially beneficial. Try to arrange for that coincidence."

Be sure to read Dr. Clark's books for complete instructions on this exciting new experimental science of *Homeography*.



# Scientific Studies on the Hulda Clark Zapper and Oscillating Electromagnetic Fields.

## ***Low-Intensity Electric Current-Induced Effects On Human Lymphocytes and Leukemia Cells***

Narendra P. Singh and Henry Lai  
Department of Bioengineering  
University of Washington  
Seattle, WA. USA

The purpose of this study is to investigate whether low-intensity current affects cells in culture. Two types of human cells: white blood cells (lymphocytes) and leukemia cells (molt-4 cells), were studied. A low-intensity time-varying electric current (0.14 milliamp) generated by the **Clark Zapper** was applied to cell cultures via two platinum electrodes for 2 hrs at 37°C. Cell counts were made at different times after electric current application. Results show that the current had no significant effect on human white blood cells up to 24 hrs after exposure, whereas it significantly inhibited the growth of leukemia cells. At 24 hrs after exposure, concentration of leukemia cells exposed to the electric current was only 58% of that of non-exposed leukemia cells. **These data suggest that the electric current can selectively inhibit the growth of leukemia cells and does not significantly affect normal cells.** A manuscript describing these results is in preparation for publication. In addition, the same electric current exposure (0.14 milliamp, 2 hrs at 37°C) was applied to E. coli bacteria cultures. No significant effect of the current was observed in E. coli cultures at 24 hrs after exposure.

Further research should investigate whether this selective electric current-induced growth inhibition also occurs in other types of cancer cells. The critical current parameters and mechanism of this effect should also be investigated.



# ***Disruption Of Cancer Cell Replication By Alternating Electric Fields***

From: <http://cancerres.aacrjournals.org/content/64/9/3288.full>

**Eilon D. Kirson, Zoya Gurvich, Rosa Schneiderman, Erez Dekel, Aviran Itzhaki, Yoram Wasserman, Rachel Schatzberger, and Yoram Palti**

## **Abstract**

Low-intensity, intermediate-frequency (100–300 kHz), alternating electric fields, delivered by means of insulated electrodes, were found to have a profound inhibitory effect on the growth rate of a variety of human and rodent tumor cell lines (Patricia C, U-118, U-87, H-1299, MDA231, PC3, B16F1, F-98, C-6, RG2, and CT-26) and malignant tumors in animals. This effect, shown to be nonthermal, selectively affects dividing cells while quiescent cells are left intact. These fields act in two modes: arrest of cell proliferation and destruction of cells while undergoing division. Both effects are demonstrated when such fields are applied for 24 h to cells undergoing mitosis that is oriented roughly along the field direction. The first mode of action is manifested by interference with the proper formation of the mitotic spindle, whereas the second results in rapid disintegration of the dividing cells. Both effects, which are frequency dependent, are consistent with the computed directional forces exerted by these specific fields on charges and dipoles within the dividing cells. *In vivo* treatment of tumors in C57BL/6 and BALB/c mice (B16F1 and CT-26 syngeneic tumor models, respectively), resulted in significant slowing of tumor growth and extensive destruction of tumor cells within 3–6 days. These findings demonstrate the potential applicability of the described electric fields as a novel therapeutic modality for malignant tumors.

## **INTRODUCTION**

In the laboratory setting and in clinical practice, alternating electric fields show a wide range of effects on living tissues. At very low frequencies (under 1 kHz), alternating electric fields stimulate excitable tissues through

membrane depolarization (1). The transmission of such fields by radiation is insignificant, and therefore they are usually applied directly by contact electrodes, although some applications have also used insulated electrodes. Some well-known examples of such effects include nerve, muscle, and heart stimulation by alternating electric fields (1, 2). In addition, low-frequency pulsed electric fields have been claimed to stimulate bone growth and accelerate fracture healing (3). However, as the frequency of the electric field increases above 1 kHz, the stimulatory effect diminishes. Under these conditions, although a greater fraction of the fields penetrates the cells, due to the parallel resistor-capacitor nature of all biological membranes, the stimulatory power greatly diminishes as the alternating cell membrane hyper-depolarization cycles are integrated such that the net effect is nulled. At very high frequencies (*i.e.*, above many MHz), although the integration becomes even more effective, a completely different biological effect is observed. At these frequencies tissue heating becomes dominant due to dielectric losses. This effect becomes more intense as frequency, field intensity, or tissue dissipation factor increases (4). This phenomenon serves as the basis for some commonly used medical treatment modalities including diathermy and radio frequency tumor ablation, which can be applied through insulated electrodes (5). Intermediate-frequency electric fields (*i.e.*, tens of kilohertz to megahertz) alternate too fast for causing nerve-muscle stimulation and involve only minute dielectric losses (heating). Such fields of low to moderate intensities are commonly considered to have no biological effect (4). However, a number of nonthermal effects of minor biological consequence have been reported even at low field intensities. These include microscopic particle alignment (*i.e.*, the pearl chain effect; Ref. 6) and cell rotation (7, 8). With pulsed electric fields of 10<sup>3</sup> V/cm and 100-ms pulse length, reversible pore formation appears in the cell membrane, a phenomenon usually called electroporation (9).

In the present study we show for the first time, to our knowledge, that very low-intensity (<2 V/cm), intermediate-frequency (100–300 kHz), alternating electric fields induced by insulated electrodes have specific inhibitory effects on dividing cells in culture. We demonstrate that applying these fields to cancerous cells leads to proliferation arrest and cell destruction. When applied to syngeneic mice tumor models, these tumor treating fields (TTFields) cause a significant reduction in tumor growth rate without any significant side effects.

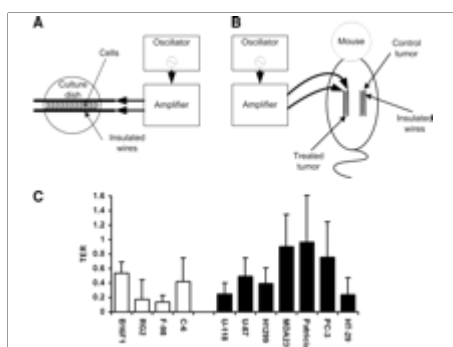
## **MATERIALS AND METHODS**

### ***In Vitro Experimental Set Up.***

Cultures were grown in standard culture dishes (4-well cell culture chambers; SN 138121; Nalge Nunc International). The TTFields were generated by pairs of 15-mm-long, completely insulated wires (P/N K-30-1000; VT Corporation; outer diameter, 0.5 mm; ethylene tetrafluoroethylene insulation thickness, 0.125 mm; dielectric breakdown, 1800 V/mil) fixed to the bottom of each dish at a distance of 1 mm from each other. The wires were connected to an oscillator (GFG8219A; Instek) and a high-voltage amplifier (A303; A. A. Lab Systems Ltd.) that generated the required sine-wave signals (range, 300–800 V). Cells were plated by carefully smearing 10  $\mu$ l of DMEM (Biological Industries Ltd., Beit Haemek, Israel) containing  $1.5 \times 10^4$  cells along the gap between the wires (Fig. 1A). After the cells settled and attached to the plate surface, 500  $\mu$ l of DMEM were added to each culture dish, which was then transferred to a 5% CO<sub>2</sub> humidified incubator held at 36°C. The culture was incubated for a control period of 24 h before treatment. Culture medium was replaced manually every 24 h throughout the experiments. TTFields were then applied by connecting the wires to a high-voltage amplifier operated by a signal generator with frequency and amplitude controls. Finite element simulation of the TTFields generated between the wires demonstrated that the field in the vicinity of the cell culture was homogenous (not shown).

Eleven different types of cancerous cell lines were subjected to TTFields. These included human melanoma (Patricia), glioma (U-118, U-87), Lung (H-1299), prostate (PC3), and breast (MDA231) cancerous cell lines as well as mouse melanoma (B16F1), rat glioma (F-98, C-6, and RG2), and mouse adenocarcinoma (CT-26) cell lines (all from American Type Culture Collection, except for Patricia, which was a generous gift from Dr. Ruth Halaban, Department of Dermatology, Yale University School of Medicine). In addition, a noncancerous cell line (BHK) was grown under conditions that stunt cell replication (0.1% FCS) and then subjected to TTFields. Also, segments of excised rat mesentery and diaphragm were subjected to the fields *in vitro*. Colorimetric cell counts were made every 24 h after seeding using the standard 2,3-bis(2-methoxy-4-nitro-5-sulfophenyl)-5-[(phenylamino)carbonyl]-2H-tetrazolium hydroxide method to measure cell proliferation as described previously (10) using cell proliferation assay kit (Biological Industries, Beit Haemek, Israel). In brief, culture media was replaced with 0.2 ml of preheated 2,3-bis(2-methoxy-4-nitro-5-sulfophenyl)-5-[(phenylamino)carbonyl]-2H-tetrazolium hydroxide reagent and incubated for 1 h at 37°C in a 5% CO<sub>2</sub> incubator. After incubation and gentle stirring, 0.15 ml of the reaction solution was transferred to a 96-well plate (SN 92696; TPP, Trasandigen, Switzerland). The absorbance of the samples was then read with a spectrophotometer (Tecan ELISA Reader; 450 nm). The colorimetric measurements at each time point were normalized to the measurement performed immediately before beginning of treatment. To verify that the colorimetric assessments were accurate, direct visual cell counts were performed on sample culture dishes. At the optic densities used (0.2–2), optic density was linearly related to the number of cells in the culture dishes ( $n = 10$ ;  $r^2 = 0.99$ ). The growth rate of both treated (GRt) and control cultures (GRc) was calculated for each experiment by plotting the optic density values on a logarithmic scale and fitting a linear regression line to the values. The growth rate for each culture dish was the slope of this linear regression. The therapeutic enhancement ratio (TER) was

calculated as the ratio of the decrease in the growth rate of treated cells compared with the growth rate of control cells  $[(GR_c - GR_t)/GR_c]$ . Thus, if the increase in the number of treated cells is equal to that of the controls,  $TER = 0$ ; if the increase in cell number is smaller in the treated cultures than in the controls,  $TER > 0$ ; and if the number of cells in the treated cultures decreases absolutely,  $TER > 1$ .



**Fig. 1.** Schematic representations of experimental setups *in vitro* (A) and *in vivo* (B) are shown. C, TTFIELDS inhibit the growth of cancerous cell lines *in vitro*.

Cultures were exposed to 100-kHz TTFIELDS at an intensity of 1–1.4 V/cm. Ordinate,  $TER$ , i.e., the ratio of the decrease in the growth rate of treated cells compared with the growth rate of control cells  $((GR_c - GR_t)/GR_c)$ . In all four animal cell lines ( $\square$ ) and seven human cell lines ( $\blacksquare$ ) tested, the ratio is greater than 0, indicating an inhibition in the growth rate of the treated cultures compared with temperature matched controls. All effects were statistically significant ( $P < 0.05$ ; Student's  $t$  test).

In time-lapse microphotography experiments, cell lines were grown on a 35-mm standard culture dish (SN 430165; Corning Inc.) by plating  $3 \times 10^4$  cells in 2.5 ml of DMEM with 25 mM HEPES. The Petri dish temperature was controlled at 34°C (B16F1) or at 37°C (all other cell lines). Subsequently, two parallel insulated wires were positioned on the bottom of the dish with 1 mm distance between through which TTFIELDS were applied. The entire set-up was placed on an inverted microscope (Eclipse TS-100; Nikon) and video microphotographs at  $\times 200$  magnification were taken with a standard VCR camera (Handicam X 320; Sony). Photographs were captured using a personal computer every 60–120 s for 6–10 h/culture.

### *Fluorescent Labeling of $\alpha$ -Tubulin, Actin, and DNA.*

Mouse melanoma cells were grown on coverslips and subjected to TTFields for 24 h. After treatment, the medium was removed, and the cells were washed in a buffer solution [10 mM 4-morpholineethanesulfonic acid, 150 mM NaCl, 5 mM EGTA, 5 mM MgCl<sub>2</sub>, and 5 mM glucose (pH 6.1)], permeabilized, and fixed with 0.5% Triton X-100 and 0.25% glutaraldehyde (Sigma) for 5 min and then post-fixed with 1% glutaraldehyde for 20 min. Subsequently, the cells were washed in PBS and 1 mM sodium borohydride (Sigma) to eliminate autofluorescence. The coverslips were then incubated with a primary antibody clone for  $\alpha$ -tubulin (DM1A; Sigma) for 30 min, washed, and incubated for 30 min with a secondary antibody (Alexa Fluor 488 goat antimouse IgG; Molecular Probes). Rhodamine-conjugated phalloidin (Sigma) was added with the secondary antibody to stain actin filaments. The cells were then washed and incubated with 4',6-diamidino-2-phenylindole (Molecular Probes) to stain the DNA. After staining, the coverslips were mounted and viewed with a fluorescence microscope at  $\times 630$  magnification and photographed.

### *Electric Field Measurement.*

The electric field intensity in the culture medium was measured by means of a probe, consisting of two (0.25 mm in diameter) insulated wires with exposed tips 0.5 mm apart, that was dipped in the culture medium. The wires were connected to a high-input impedance differential amplifier that translated the waveform amplitude into a calibrated steady voltage that was digitally recorded. Field intensities throughout the manuscript are expressed in peak voltage amplitude per centimeter (V/cm). Care was taken to eliminate any pickup from the field outside the culture medium. Continuous field monitoring could also be made by measuring the potential drop across a 100 $\Omega$  resistor placed in series with one of the field-generating wires. The voltage drop on this resistor was linearly correlated to the field intensity ( $r^2 = 0.96$ ). To verify that the experimental setups were not exposed to any significant magnetic fields, the electromagnetic radiation in the immediate

vicinity of the treated cultures was measured using a loop antennae (EMCO 6507 1 kHz to 30 MHz) connected to a spectrum analyzer (Anritsu 9 kHz to 2.2 GHz). The electromagnetic radiation in the 100–300-kHz range within the incubators containing treated culture dishes was found to be 10–12 Tesla and within animal cages containing TField-treated mice, 10–14 Tesla, *i.e.*, negligible.

#### *Finite Element Simulations of Electric Field Distribution.*

The calculations of the electric field within the cells are based on finite element mesh (11), using a simplified description of the cell morphology (see Fig. 7). In all calculations, the dielectric constant of both the cytoplasm and medium was 80, their conductance was 0.3 S/m, the cell diameter was 10 μm, and the membrane thickness was 3 nm (with a dielectric constant of 3). The electric field intensity was mapped within the cell, based on the amplitude (1 V/cm), frequency (100 kHz) and waveform (sine) of the electric field applied to the cell culture. The force exerted by an inhomogeneous field, such as that created inside the cells on a single tubulin dimer, was calculated based on the direct interaction between the electric field and the dipole. The force exerted on a microscopic polarizable organelle was calculated by the following equation (12):

$$\langle \mathbf{F} \rangle = \frac{1}{2} \operatorname{Re} \left\{ \epsilon_m \nabla \cdot \left( \frac{K(\omega) \mathbf{E}}{K(\omega) + 1} \right) \right\} \quad \text{where } \langle \mathbf{F} \rangle \text{ is the}$$

expectation value of the force vector,  $\operatorname{Re}$  symbolized the real component of the variable,  $\nabla \cdot$  is the divergence of the variable,  $\epsilon_m$  is the cytoplasm dielectric constant,  $r$  is the tubulin dimer length or particle radius,  $E_{RMS}$  is the RMS value of the electric field, and  $K(\omega)$  is the Clausius-Mossotti factor:

$$K(\omega) = \frac{\epsilon_p^* - \epsilon_m^*}{\epsilon_p^* + 2\epsilon_m^*} \quad \epsilon^* = \epsilon - i \cdot \frac{\sigma}{\omega} \quad \text{where } \epsilon_p^*, \epsilon_m^* \text{ are the complex dielectric constants of the particle and cytoplasm respectively, each of which is}$$

calculated from the dielectric constant ( $\epsilon$ ) and conductance ( $\sigma$ ) as a function of frequency ( $\omega$ ).  $K(\omega)$  in this case is always positive at the relatively low frequencies used (*i.e.*, 100 kHz), assuming that at these frequencies,  $\epsilon_p > \epsilon_m$ . This means that the force acting on a polarizable particle will always act in the direction of the convergence of the electric field lines. The terminal velocity of particles due to these forces was calculated using Stoke's law.

### ***In Vivo Experimental Setup.***

TTFIELD treatment was applied by means of 10-mm-long pairs of parallel, insulated wires (outer diameter, 0.5 mm; insulation thickness, 0.125 mm; Tefzel) placed intradermally on the back of a mouse. Another pair of identical wires was placed parallel to the first pair in each mouse, with an interval of 5 mm between the pairs. Cell line inoculums were injected (4  $\mu$ l;  $3 \times 10^5$  cells) intradermally in between the two members of each pair of implanted wires. Only one pair was then connected to a voltage amplifier to apply 100 kHz of TTFIELDS treatment to one tumor. The other pair of wires was left disconnected, and the tumor between them served as a paired control of the treated tumor (see Fig. 1B). Tumors were measured using a caliper. Tumor size was calculated by multiplying maximal tumor length by maximal tumor width. Animal experiments were conducted in accordance with the Technion—Israel Institute of Technology guidelines for the care of laboratory animals.

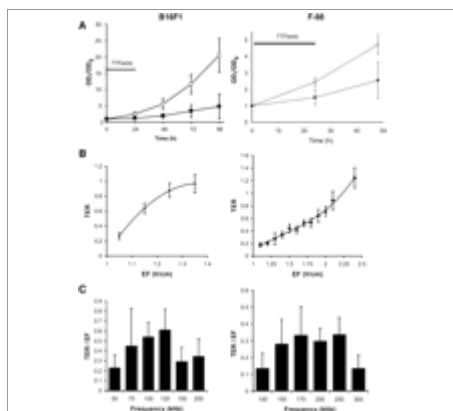
## **RESULTS**

### ***Effect of TTFIELDS on Cells in Culture.***

More than 500 culture dishes were exposed to TTFIELDS. The number of cells in each treatment dish was assessed periodically using colorimetric determination (as described in "Materials and Methods"). Because under control conditions, most of the cell lines had doubling times of less than 24 h (range, 17–24 h; except for PC-3 for which the doubling time was 73 h), treatment duration was at least 24 h. Exposure began 24 h after seeding and was continued for up to 72 h. In all cell lines tested, 24-h exposure to



TTFIELDS at 100 kHz (at an intensity of 1.0–1.4 V/cm) caused significant inhibition of cell proliferation (TER range, 0.14–0.96;  $P < 0.05$ ; Fig. 1C). This effect lasted beyond the exposure time of the cells to TTFIELDS. In fact in some experiments (e.g., malignant melanoma), culture growth was stunted for as long as 72 h after TTFIELD exposure was terminated (Fig. 2A).



### Fig. 2.

Time, field frequency, and intensity dependence of the effect of TTFIELDS on malignant melanoma (B16F1, left column) and glioma cell (F-98, right column) proliferation. A, the number of cells in untreated cultures (control; □)

as compared with cultures treated with TTFIELDS (•). The number of cells at each time point ( $OD_i$ ) was normalized by the number of cells in the culture before initiation of treatment ( $OD_0$ ). The number of control cells is seen to roughly double every 24 h throughout the experiment. TTFIELDS were applied for 24 h continuously (solid lines) at 100 kHz in the melanoma cultures and at 200 kHz in the glioma cultures. The increase in the number of treated melanoma (left) and glioma (right) cells over time is significantly smaller than control cells ( $P < 0.001$ ). B, the effect of 24-h exposure to TTFIELDS of increasing intensities. The magnitude of the effect is expressed using the TER. The inhibitory effect of the TTFIELDS on proliferation increases with intensity in both cell types. Complete proliferation arrest (TER = 1) is seen at 1.35 and 2.25 V/cm in melanoma and glioma cells, respectively. EF, electric field. C, change in the melanoma (left) and glioma (right) growth rate after 24 h of exposure to TTFIELDS of different frequencies is normalized to the field intensity (TER/EF). A window effect is seen with maximal inhibition by TTFIELDS at 120 kHz in melanoma cells and at ~200 kHz in glioma cells. Data are mean + SE.

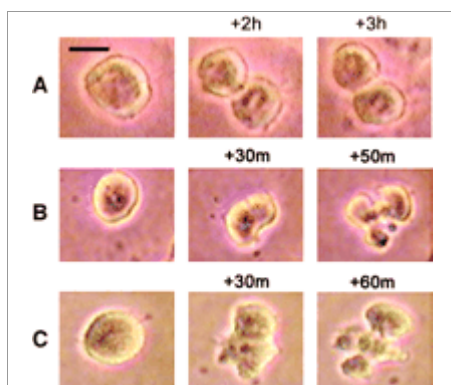
We next checked whether nonreplicating cultures and tissues are affected by TFields. BHK cultures were maintained in low-serum (0.1% FCS) conditions to slow their replication rate. These cultures were then exposed to 100 kHz of TFields (at an intensity of 1.2 V/cm) for 24 h. No significant difference in cell number between control and TField-treated cultures was observed under these conditions ( $P = 0.97$ ). After returning these cultures to normal media (10% FCS), normal replication resumed both in cultures exposed to TFields and in control cultures. We also tested the effect of TField treatment on the number of viable cells in nonreplicating tissues dissected from rats. Four segments of rat mesentery and four segments of rat diaphragm were exposed to 100 kHz of TFields at an intensity of 1.2 V/cm for 24 h. No differences were observed between the number of viable cells in both types of treated tissues compared with control tissues (mesentery,  $P = 0.3$ ; diaphragm,  $P = 0.54$ ).

To test the relationship between TField intensity and inhibition of cell proliferation, mouse melanoma (B16F1) and rat glioma (F-98) cell lines were exposed to TFields of different intensities between 1 and 2.5 V/cm. The inhibitory effect of TFields on cell proliferation increased as intensity was raised (Fig. 2B) until complete proliferation arrest was achieved at intensities of 1.4 and 2.25 V/cm in melanoma and glioma cells, respectively. The effects of TFields are expected to be frequency dependent in view of the dependence of cell membrane electric impedance on frequency (due to the cell membrane capacitance). These changes in impedance render the fraction of field penetrating the cells a function of frequency. Therefore, we tested the frequency dependence of the inhibitory effect of TFields on growth rate of cultured melanoma (B16F1) and glioma (F-98) cells. Comparison between the efficacy of the TFields at different frequencies was performed by normalizing the TER to the electric field intensity. As seen in Fig. 2C, the inhibitory effect of TFields was frequency dependent. Interestingly, the frequency at which maximal inhibition was achieved differed between cell types (120 kHz *versus* ~200 kHz for melanoma and

glioma, respectively).

*The Effects of TFields on Cellular and Molecular Processes in Proliferating Cells.*

To gain insight into the cellular processes by means of which TFields affect cell proliferation, time-lapse microphotography was performed while TFields were applied to mouse melanoma cultures (see “Materials and Methods”). Several unique processes became evident in time-lapse microphotography of TField-treated cultures. The most pronounced phenomenon was prolongation of mitosis. In the treated cells, mitosis seemed to begin normally but was prolonged for variable periods of time before completing cleavage into two daughter cells. Fig. 3A shows an exemplary mitosis in a TFields-treated cell. As seen in the treated cell, mitosis was not complete within 3 h. Due to this proliferation arrest, in treated cultures, mitosis lasted on average  $124 \pm 91$  min (mean  $\pm$  SD,  $n = 53$ ; range, 40–541 min), whereas under control conditions, average mitosis duration was  $62 \pm 8$  min from cell rounding to cytokinesis (mean  $\pm$  SD,  $n = 12$ ; range, 47–78 min). This prolongation is statistically significant ( $P < 0.01$ , Mann-Whitney  $U$  test).



**Fig. 3.** Time-lapse microphotography of malignant melanoma cells exposed to TFields. *A*, an example of a cell in mitosis arrested by TFields. Contrary to normal mitosis, the duration of which is less than 1 h,

the depicted cell is seen to be stationary at mid-cytokinesis for 3 h. *B* and *C*, two examples of disintegration of TFields-treated cells during cytokinesis. Three consecutive stages are shown: cell rounding (*left*); formation of the cleavage furrow (*middle*); and cell disintegration (*right*). Scale bar = 10  $\mu$ m.

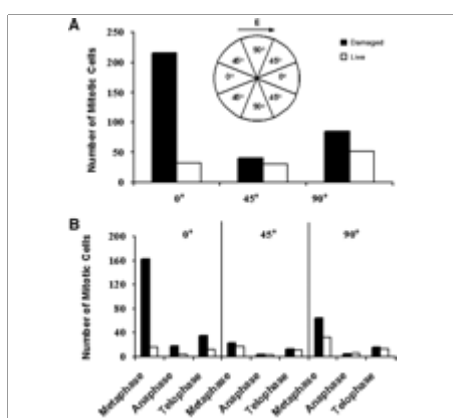
The second major phenomenon, seen in the TField-treated melanoma cultures, was that one-fourth of cells undergoing mitosis were destroyed as

the formation of the cleavage furrow approached complete cell separation. During this process, the cell membrane ruptured, and many small membrane blebs formed, resembling post-mitotic apoptotic cell death (13). Two exemplary cells undergoing such destruction are shown in Fig. 3, *B* and *C*. Destructive effects were observed only in mitotic cells, whereas quiescent cells remained morphologically and functionally intact.

The third phenomenon, seen only in TTFIELD-treated cultures, was nuclear rotation. In early mitosis, after cell rounding, nuclei could be seen rotating within the cell. A full rotation lasted on average 15 min. This effect resembles the whole-cell rotation previously described during exposure to intermediate-frequency alternating electric fields (7, 8).

A fundamental characteristic of electric fields is that at any point in space, they have a defined orientation corresponding to the direction of the force they exert on charges and polar elements. With regard to the latter, the force exerted by the field is maximal when the dipole is oriented in the direction of the field. With regard to the above, there are two main structural differences between quiescent and dividing cells. One is that the latter contain highly polar, spatially oriented microtubules and that they develop a directional, hourglass-shaped cell morphology during the cytokinesis phase. In view of these facts, one may expect that the electric field forces will have maximal effect on the mitotic process when it is oriented along the lines of force of the field. To investigate this point, we fixed melanoma cell cultures and stained them with toluidine blue, immediately after 24 h of TTFIELD treatment, to demonstrate mitoses and to distinguish vital from damaged or dead cells. The live and damaged mitotic cells (at the time of fixation) were grouped according to the orientation of their cleavage axis relative to the electric field direction. The cells were counted separately in each of four equal sectors that form angles of  $0^\circ$ ,  $45^\circ$  (two sectors, 45 and 135), and  $90^\circ$  relative to the field direction. As seen in Fig. 4A, the live cells were randomly distributed in all sectors. In contrast, a much higher proportion of the damaged cells had their axis of division

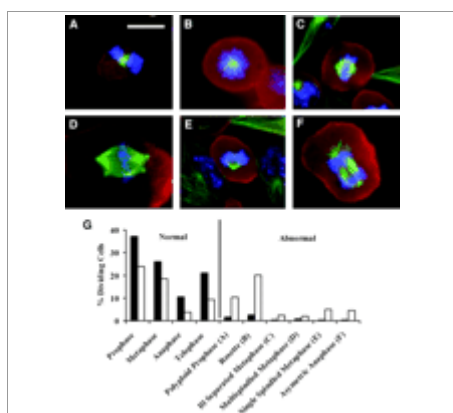
oriented along the field: 56% at 0° versus an average of 15% in each of the other orientations. Surprisingly, the number of cells per unit area in the two 45° sectors was found to be one-half that in the 0° sector. This finding may serve as an indication of an additional effect of TFields: orientation of the cell division in the field direction. The cells in each of the above spatially oriented defined groups were further divided according to stages of mitosis at the time of fixation. At all stages, a higher fraction of damaged cells had their axis of division oriented along the field. Moreover, 74% of the parallel oriented cells were damaged while being in metaphase (Fig. 4B).



**Fig. 4.** Dependency of TFields-induced cellular damage on the orientation axis of cell division relative to field direction. *Ordinate* represents the number of mitotic cells counted in four TField-treated malignant melanoma cultures (100 kHz). A,

total number of damaged (■) and live (□) mitotic cells in each of three sectors of different angles relative to the field direction (*inset*). The number of damaged cells is more than 5-fold larger than the corresponding number of live cells when division is aligned at or close to 0° relative to the electric field direction. In sectors of other angles, the number of damaged cells only slightly exceeds the live ones. Note that because the 45° area is double that of each of the other two sectors, the number of cells presented in this orientation was halved. B, dividing cell sensitivity to fields of different orientation at different stages of mitosis. When cell division axis is aligned at 0° to the electric field, the number of damaged cells (■) is significantly larger than that of intact cells (□) at all three phases of mitosis. However, the highest number of damaged cells in this orientation is seen at metaphase (8-fold more than intact cells).

The spatially organized mitotic spindle, which forms in dividing cells, consists of microtubules that have very large electric dipole moments (14) and may therefore be disoriented by the forces of the electric fields (15, 15). Actin filaments are also polar, however, they have no defined spatial orientation within the cells and are therefore not expected to be significantly affected by the fields. This prompted us to test whether TFields disrupt mitosis by interfering with the normal formation, orientation, and movement of microtubules as compared with actin filaments as follows: Melanoma cell cultures were treated with TFields for 24 h. After treatment, the cells were fixated, stained with monoclonal antibodies directed against microtubules and actin filaments, as well as for DNA, and thereafter studied with fluorescence microscopy (see "Materials and Methods"). In control cultures, 95% of cells undergoing mitosis exhibited the normal stages of mitosis with intact mitotic spindles. However, in TField-treated cultures, more than one-half of the mitoses were abnormal. Fig. 5 shows examples of the different forms of abnormal mitosis seen under TField treatment. These included polypoid cells in prophase, ill-separated, multi-spindled and single-spindled cells in metaphase, asymmetric anaphases, and a large proportion of cells in metaphase (>20%) with rosette shaped chromosome assemblies. The normal and abnormal stages of mitosis in control and TField-treated cultures are summarized and compared in Fig. 5G. In general, these abnormalities may serve as an indication of interference of TFields with the normal behavior of the microtubules. In contrast, staining for actin filaments showed no difference between TField-treated and control cultures.

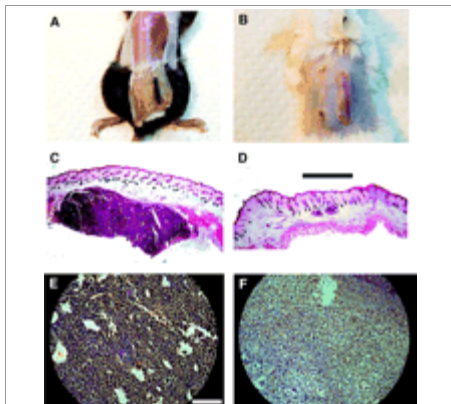


**Fig. 5.** Immunohistochemical staining of abnormal mitotic figures in TFields-treated cultures. Malignant melanoma cultures ( $n = 4$ ) were treated for 24 h at 100

kHz and then stained with monoclonal antibodies for microtubules (*green*), actin (*red*), and DNA (*blue*). The photomicrographs show exemplary abnormal mitoses including: polyploid prophase (*A*); rosette (*B*); ill separated metaphase (*C*); multispindled metaphase (*D*); single-spindled metaphase (*E*); and asymmetric anaphase (*F*). *G*, the percentage of treated (□) and control (▪) mitotic cells in each of the normal and abnormal phases of mitosis. Effect of TFields on Tumors **in Vivo.**

To test whether TFields are effective in destroying tumor cells *in vivo*, we tested their effect on two animal tumor models: C57BL/6 mice inoculated intradermally with malignant melanoma cells (B16F1) and BALB/c mice inoculated intradermally with adenocarcinoma cells (CT-26). TFields were generated between implanted (intradermal) wholly insulated wires placed on both sides of the tumor (see Fig. 1*B*). Mice with implanted electrodes were treated for 3–6 days continuously beginning 1 day after cell line inoculation. We found that 100–200 kHz of TFields at low intensities of <2 V/cm effectively inhibited malignant melanoma growth compared with the growth of nontreated control tumors. Photographs of examples of treated and nontreated malignant melanoma tumors are given in Fig. 6 for comparison. Treated tumors were significantly smaller than control tumors at the end of treatment (average treated tumor size was 47% of control tumor size;  $n = 78$  mice,  $P < 0.001$ ; Student's  $t$  test). Histopathological analysis of treated tumors showed extensive necrosis with aggregations of kariorrhetic and kariolytic debris (Fig. 6*F*). To test whether TFields are effective on different tumor types, BALB/c mice with intradermal adenocarcinomas were treated with the same field parameters. Photographs of examples of such a treated and a nontreated adenocarcinoma tumors are provided for comparison in Fig. 6*B*. The average effect of TFields on adenocarcinoma carrying mice was less dramatic than that seen for malignant melanoma (average treated tumor size was 73% of control tumor size at the end of treatment;  $n = 14$  mice). After treatment, the tumors and

their adjacent tissues were fixated, stained with H&E, and analyzed histopathologically. No damage to the surrounding tissues was detected.



**Fig. 6.**  
*In vivo* effects of TTFields on intradermal tumors in mice. Malignant melanoma (A) and adenocarcinoma (B) tumor cells were injected in two parallel locations intradermally on the back of each mouse. Only the tumor on

the left side of the mouse was treated. After 4 days of TTFields treatment (at 100 kHz), no tumor can be discerned on the treated side, whereas on the untreated side a large tumor has grown. C–F, histological sections of TTFields-treated intradermal melanoma *versus* a control (untreated) melanoma on the same mouse. C, after H&E staining, a large (5 mm diameter) nodule of melanoma cells can be seen in the dermis of the control tumor ( $\times 40$ ). Note that due to the large size of the tumor, its deep portion has been lost in preparation. D, treated tumor; only two small ( $<0.4$  mm diameter) nodules are present (*scale bar* = 0.5 mm). The nontumor structures of the dermis are morphologically intact. E, control tumor, malignant melanoma cells appear intact and viable ( $\times 200$ ). (*Scale bar* = 100  $\mu\text{m}$ ). F, only necrotic tissue and cellular debris are seen in the treated tumor.

## DISCUSSION

In this study, we have shown that when properly tuned, very low-intensity, intermediate-frequency electric fields (TTFields) stunt the growth of cancerous cells. We have demonstrated this inhibitory effect in all proliferating cell types tested, whereas, nonproliferating cells and tissues were unaffected. Interestingly, different types of cancerous cells showed specific intensity and frequency dependences of TTField inhibition. We have



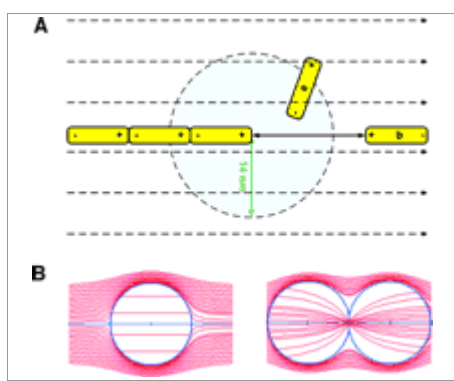
demonstrated that two main processes occur at the cellular level during exposure to TFields: arrest of proliferation and cell destruction. The damage caused by TFields to these replicating cells was shown to be dependent on the orientation of the division process in relation to the field vectors, indicating that this effect is nonthermal. Indeed, temperature measurements made within culture dishes during treatment and on the skin above treated tumors *in vivo*, showed no significant elevation in temperature compared with control cultures/mice. Also, TFields caused the dividing cells to orient in the direction of the applied field in a manner similar to that described in cultured human corneal epithelial cells exposed to constant electric fields (17). At the subcellular level, we have found evidence indicating that TFields disrupt the normal polymerization-depolymerization process of microtubules during mitosis. Indeed, the described abnormal mitotic configurations seen after exposure to TFields are similar to the morphological abnormalities seen in cells treated with agents that interfere directly (18, 19) or indirectly (20,21,22) with microtubule polymerization (*e.g.*, Taxol). To explain how TFields cause orientation-dependent damage to dividing cancerous cells and disrupt the proper formation of the mitotic spindle, we modeled the forces exerted by TFields on intracellular charges and polar particles using finite element simulations (see "Materials and Methods"). We identified two main mechanisms by means of which the electric fields may affect dividing cells. The first relates to the field effect on polar macromolecule orientation. Within this framework, during the early phases of mitosis, *i.e.*, in pre-telophase, when tubulin polymerization-depolymerization drives the proliferation process, the electric field forces any tubulin dimers, positioned further than 14 nm away from the growing end of a microtubule, to orient in the direction of the field (Fig. 7A). This force moment, ( $10^{-5}$  pN) acting on the dimers, is sufficient to interfere with the proper process of assembly and disassembly of microtubules that is essential for chromosome alignment and separation (23). This effect can explain the mitotic arrest of

TFields-treated cells (24). The second mechanism, which interferes with cell division and is most likely to play an important role in cell destruction, becomes dominant during cleavage. As seen in the simulations depicted in Fig. 7B, the electric field within quiescent cells is homogenous, whereas the field inside mitotic cells, during cytokinesis, is not homogenous. We see an increased field line concentration (indicating increased field intensity) at the furrow, a phenomenon that highly resembles the focusing of a light beam by a lens. This inhomogeneity in field intensity exerts a unidirectional electric force on all intracellular charged and polar entities, pulling them toward the furrow (regardless of field polarity). For example, for a cleavage furrow that reached a diameter of 1  $\mu\text{m}$  in an external field of only 1 V/cm, the force exerted on the microtubules is in the order of 5 pN. This magnitude is compatible with the reported forces necessary to stall microtubule polymerization that is 4.3 pN (25). With regard to other particles such as cytoplasmatic organelles, they are polarized by the field within dividing cells. Once polarized, the forces acting on such particles may reach values up to an order of 60 pN resulting in their movement toward the furrow at velocities that may approach 0.03  $\mu\text{m/s}$ . At such velocity, cytoplasmatic organelles would pile up at the cleavage furrow within a few minutes, interfering with cytokinesis and possibly leading to cell destruction. We also found that the electric forces acting on intracellular particles are maximal when the axis of division is aligned with the external field. This is consistent with the dependence of the destructive effect of TFields on the angle between division axis and the field (Fig. 4). In addition, the calculated dependence of the magnitude of this force on frequency (data not shown) is consistent with the experimentally determined frequency dependence of the inhibitory effect of TFields on melanoma and glioma cell proliferation

(Fig. 2C).

**Fig. 7.**

A, schematic representation of two



tubulin dimers positioned near the tip of an elongating microtubule in a dividing cell. The force that a 1-V/cm extracellular TTF field exerts on a tubulin dimer located less than 14 nm away from the microtubule (*a*) is smaller than the force exerted by the polar microtubule tip, and therefore it will align according to the field generated by the microtubule. In contrast, dimers further than 14 nm from the end of the microtubule (*b*) are aligned by the forces of the TTF fields (*dashed lines*) in a direction that may not be compatible with the polymerization-depolymerization process. *B*, finite element mesh simulation of the lines of force of the electric field inside a quiescent cell (*left*) and a cell undergoing mitotic cytokinesis (*right*). The diameters of the cells in the simulations was 10  $\mu\text{m}$  and membrane thickness 3 nm. Inside the quiescent cell, the electric field is mostly uniform (equal distances between the lines of force). In contrast, in the dividing cell, the field is inhomogeneous—the field intensity (*line density*) increases toward the cleavage furrow.

In conclusion, we have demonstrated that TTF fields inhibit both the proliferation of malignant cells in culture and the growth of tumors in mice while showing no general side effects or local histopathological damage. The mechanism of action of the fields is, at least in part, dependent on disruption of the microtubules of the mitotic spindle and the electric forces resulting from focusing of the field in the dividing cells. The highly specific effects of these fields on dividing cells, together with the relative ease of applying them, focusing them, and screening from them, make them an attractive candidate to serve as a novel treatment modality for cancer.

### Footnotes

**Grant support:** NovoCure Ltd.

The costs of publication of this article were defrayed in part by the payment of page charges. This article must therefore be hereby marked *advertisement* in accordance with 18 U.S.C. Section 1734 solely to indicate this fact.

**Requests for reprints:** Yoram Palti, Department of Physiology, B. Rappaport Faculty of Medicine, Technion—

Israel Institute of Technology, Haifa 31906, Israel. Phone: 972-4-8501204; Fax: 972-4-8501207; E-mail: yoramp@netvision.net.il.

Received January 11, 2004. Revision received February 12, 2004. Accepted February 17, 2004.

1 Department of Biomedical Engineering, NovoCure Ltd., Haifa, Israel; 2 B. Rappaport Faculty of Medicine, Technion—Israel Institute of Technology, Haifa, Israel; 3 Department of Molecular Cell Biology, Weizmann Institute of Science, Rehovot, Israel; and 4 Elisha Medical Centre, Haifa, Israel

## References

1. Polk C Therapeutic applications of low-frequency sinusoidal and pulsed electric and magnetic fields Bronzino JD eds. *The biomedical engineering handbook*, p. 1404-16, CRC Press, Inc. Boca Raton, FL 1995.
2. Palti Y Stimulation of internal organs by means of externally applied electrodes. *J Appl Physiol*, **21**: 1619-23, 1966.
3. Basset CA The development and application of pulsed electromagnetic fields (PEMFs) for ununited fractures and arthrodeses. *Clin Plast Surg*, **12**: 259-77, 1985.
4. Elson E Biologic effects of radiofrequency and microwave fields: in vivo and in vitro experimental results Bronzino JD eds. *The biomedical engineering handbook*, p. 1417-23, CRC Press, Inc. Boca Raton, FL 1995.
5. Chou CK Radiofrequency hyperthermia in cancer therapy Bronzino JD eds. *The biomedical engineering handbook*, p. 1424-30, CRC Press, Inc. Boca Raton, FL 1995.
6. Takashima S, Schwan HP Alignment of microscopic particles in electric fields and its biological implications. *Biophys J*, **47**: 513-8, 1985.
7. Zimmermann U, Vienken J, Pilwat G Rotation of cells in an alternating electric field: the occurrence of a resonance frequency. *Z Naturforsch C*, **36**: 173-7, 1981.
8. Holzapfel C, Vienken J, Zimmermann U Rotation of cells in an alternating electric field: theory and experimental proof. *J Membr Biol*, **67**: 13-26, 1982.
9. Pawlowski P, Szutowicz I, Marszalek P, Fikus M Bioelectrorheological model of the cell. 5. Electrodestruction of cellular membrane in alternating electric field. *Biophys J*, **65**: 541-9, 1993.
10. Jost LM, Kirkwood JM, Whiteside TL Improved short- and long-term XTT-based colorimetric cellular cytotoxicity assay for melanoma and other tumor cells. *J Immunol Methods*, **147**: 153-65, 1992.
11. Volakis JL, Chatterjee A, Kempel LC. *Finite element method electromagnetics: antennas, microwave circuits, and scattering applications*, IEEE/OUP New York, NY 2001.
12. Pohl AH. *Dielectrophoresis*, Cambridge University Press Cambridge, UK 1978.
13. Endlich B, Radford IR, Forrester HB, Dewey WC Computerized video time-lapse microscopy studies of ionizing radiation-induced rapid-interphase and mitosis-related apoptosis in lymphoid cells. *Radiat Res*, **153**: 36-48, 2000.
14. Alberts B, Roberts K, Lewis J, Raff M, Watson JD. *Molecular biology of the cell*, 2nd ed. p. 1216 Garland Publishing, Inc. New York 1989.
15. Meggs WJ Electric fields determine the spatial organization of microtubules and actin filaments. *Med Hypotheses*, **26**: 165-70, 1988.
16. Cho MR, Thatte HS, Lee RC, Golan DE Reorganization of microfilament structure induced by ac electric fields. *FASEB J*, **10**: 1552-8, 1996.
17. Zhao M, Forrester JV, McCaig CD A small, physiological electric field orients cell division. *Proc Natl Acad Sci USA*, **96**: 4942-6, 1999.
18. Jordan MA, Thrower D, Wilson L Effects of vinblastine, podophyllotoxin and nocodazole on mitotic spindles: implications for the role of microtubule dynamics in mitosis. *J Cell Sci*, **102**: 401-16, 1992.
19. Rowinsky EK, Donehower RC Paclitaxel (Taxol). *N Engl J Med*, **332**: 1004-14, 1995.
20. Kline-Smith SL, Walczak CE The microtubule-destabilizing kinesin XKCM1 regulates microtubule dynamic instability in cells. *Mol Biol Cell*, **13**: 2718-31, 2002.
21. Kapoor TM, Mayer TU, Coughlin ML, Mitchison TJ Probing spindle assembly mechanisms with

- monastrol, a small molecule inhibitor of the mitotic kinesin, Eg5. *J Cell Biol*, **150**: 975-88, 2000.
22. Maiato H, Sampaio P, Lemos CL, et al MAST/Orbit has a role in microtubule-kinetochore attachment and is essential for chromosome alignment and maintenance of spindle bipolarity. *J Cell Biol*, **157**: 749-60, 2002.
  23. Gagliardi LJ Electrostatic force in prometaphase, metaphase, and anaphase-A chromosome motions. *Phys Rev E Stat Nonlin Soft Matter Phys*, **66**: 011901 2002.
  24. Fishkind DJ, Silverman JD, Wang YL Function of spindle microtubules in directing cortical movement and actin filament organization in dividing cultured cells. *J Cell Sci*, **109**: 2041-51, 1996.
  25. Dogterom M, Yurke B Measurement of the force-velocity relation for growing microtubules. *Science*, **278**: 856-60, 1997.

### Articles citing this article

Mild Electrical Stimulation at 0.1-ms Pulse Width Induces p53 Protein Phosphorylation and G2 Arrest in Human Epithelial Cells

*J Biol Chem* May 31, 2013 288:16117-16126

[Abstract](#)[Full Text](#)[Full Text \(PDF\)](#)

Growth Inhibition of Malignant Melanoma by Intermediate Frequency Alternating Electric Fields, and the Underlying Mechanisms

*Journal of International Medical Research* February 1, 2012 40:85-94

[Abstract](#)[Full Text \(PDF\)](#)

Microbial Growth Inhibition by Alternating Electric Fields in Mice with *Pseudomonas aeruginosa* Lung Infection

*Antimicrob. Agents Chemother.* August 1, 2010 54:3212-3218

[Abstract](#)[Full Text](#)[Full Text \(PDF\)](#)

Electrical dimensions in cell science

*J. Cell Sci.* December 1, 2009 122:4267-4276

[Abstract](#)[Full Text](#)[Full Text \(PDF\)](#)

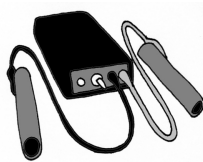
Microbial Growth Inhibition by Alternating Electric Fields

*Antimicrob. Agents Chemother.* October 1, 2008 52:3517-3522

[Abstract](#)[Full Text](#)[Full Text \(PDF\)](#)

Alternating electric fields arrest cell proliferation in animal tumor models and human brain tumors

*Proc. Natl. Acad. Sci. USA* June 12, 2007 104:10152-10157



# ***Bioelectrical Stimulation for People with Patterns Consistent with Certain Chronic Infections***

From: <http://www.healthresearch.com/zappers.htm>

Originally Published in the *American Naturopathic Medical Association Monitor* and the *Townsend Letter for Doctors & Patients*

Dr. Thiel runs a clinic in Arroyo Grande, County of San Luis Obispo, California. A recently published study found that he was able to help 929 of 945 Who Saw Dr. Thiel Reported Improvement.

Bioelectrical stimulation is one of the modalities that he uses at times. He can help you or a loved one. Call 1-805-489-7188 to schedule an appointment.

Robert Thiel, Ph.D., Naturopath, Director of Research, Doctors' Research

Key words: infections, bioelectrical stimulation, zappers, nutrition, parasite, fungi, virus, staphylococci, streptococci, alternative health, antibiotic alternatives

## **ABSTRACT**

The purpose of this pilot trial was to determine whether there may be any efficacy to combining the use of bioelectrical stimulating units with nutritional interventions for people with patterns consistent with chronic fungal, bacterial, viral, or parasitic infections. This trial was a pretest-posttest, natural control-group design where subjects were assessed before and after bioelectrical stimulation was introduced by the use of a device, most commonly referred to as a **zapper**. 140 of 143 (97.9%) participants reported improvement within 45 days,  $P < .01$ ; 48.2% improved substantially and 49.7% improved minimally. Thus, it appears that combining bioelectrical stimulation with nutritional interventions may have efficacy and deserves further study.

Thiel R. Bioelectrical Stimulation for People with Patterns Consistent with Certain Chronic Infections. *ANMA Monitor*, 1998; 2(4):5-9

Thiel R. Bioelectrical Stimulation for People with Patterns Consistent with Certain Chronic Infections. *Townsend Letter*, 2000; 203:65-67

## **INTRODUCTION**

Reports of infections are on the increase [1-4]. Within the past two decades, at least twenty new infectious diseases (or new presentations of old infectious diseases) have become universally recognized as problems for humans [3,4]. Increases of infections are believed to be caused by changes in lifestyle, diet, agricultural practices, travel, and medical interventions [2-4]. Regarding medical

interventions, the excessive use of antibiotics has led to an increase of bacteria which are resistant to antibiotics [5]. This, in turn, has led to the development of stronger antibiotics, which then has led to an increase of the amounts of strains of bacteria which are resistant to antibiotics [5,6]. There is even a strain of staphylococcus aureus that was initially described as "a deadly bacterium that can resist every drug in science's infection-treatment arsenal" [7]. Approaches other than antibiotics are needed to deal with these and other infections [2,5].

One approach, as advocated by Hulda Clark (Ph.D., N.D.), involves the use of bioelectrical stimulation (which she terms: zapping) combined with herbal interventions [2]. Dr. Clark believes that all invading organisms are parasitic and can be destroyed by zapping or by being exposed to an electronic field at a frequency taken from its own bioradiation band width, and that devices exist which can generate the proper frequencies. Similar to my hypothesis that all matter appears to emit some type of electro-magnetic energy [8], Dr. Clark has hypothesized that all living matter emits some type of high frequency energy (which she terms as "bioradiation?"). Dr. Clark believes that a particular frequency range for each form of living matter can be identified and that a lethal effect can be obtained through a device she refers to as a zapper [2]. Others have made units which predate her comments, even back in the 19th Century [9,10].

Actually, instructions on how to make such devices are now nearly universally available from a variety of copyrighted sources (and these devices are often made and used by the lay public without any type of supervision) [2,9,11,12]. Dr. Clark has stated that a zapper can selectively electrocute parasitic organisms without adversely affecting humans because humans are not harmed by such a low voltage (9v) and that the frequencies that affect parasites are sufficiently far removed from those that could bother humans [2]. A clinical trial was performed to determine if such interventions may have any efficacy when combined with nutritional interventions.

## **MATERIALS AND METHOD**

Non-HIV infected adults were eligible for inclusion in this pretest-posttest trial if they resided in California, came to our office, agreed to provide (and did provide) feedback, signed a consent agreement, had evidence of a pattern of chronic infection consistent within the scope of this trial, had not completely responded to previous nutritional interventions, were not pregnant, did not wear a pacemaker, underwent at least one zapping session, and followed the nutritional recommendations. The natural control group met the same criteria, except that they did not undergo a zapping session.

This report includes every subject who met these criteria during the twelve month time period of this trial. 158 people were eligible, but 15 failed to provide the required feedback. Of the 143 actual participants, 41 of the participants were male and 102 were female. Ages ranged from 5 to 84 years. 34 were in the

natural control group, but 3 failed to provide the required feedback. Of the 31 actually in the natural control group 9 of them were male and 22 of them were female; ages ranged from 4-82. All were interviewed for approximately 30 minutes. Signs and symptoms associated with their possible infections were noted. Five categories of infection were considered without regard to specific species, strains, or varieties. All continued with their nutritional recommendations (taking commercially available vitamin, herbal, and glandular combinations), including dietary restrictions when involved. As the nutritional interventions, have been written about extensively elsewhere by this investigator [8,13-15] and are not the independent variable being tested in this trial, they are not detailed in this paper. Subjects then underwent one or more zapping sessions. Subjects were re-interviewed approximately three weeks later to determine any change.

As the State of California does not allow naturopaths to order medical tests, changes in health in this pilot trial was based upon subject reports of improvement. A zapping session consisted of having the participant hold a zapping unit (two different ones were used in this study) three times for between 7 to 15 minutes each time, with a break of between 10-20 minutes (time varied depending upon the zapper used).

Two different zappers were used: A commercial model and a specially engineered model. The commercial model used was a SyncroZap Pulse Generator Model B3 from Self Health Resource Center, Imperial Beach, California; it is operated by a 9 volt battery and produces a 32KHz output. The engineered model was based upon the same design as the commercial model (was also operated by a 9 volt battery), but due to an extra integrated circuit, its output sweeps the frequency in steps of 2 KHz from 20 - 40 KHz (this sweeping is believed by the developer to generate an output at 10 times as many frequencies than the commercial model). The commercial model was normally held for 7 minutes with 15-20 minute breaks, while the engineered model was normally held for 15 minutes with 10 minute breaks.

## **RESULTS**

Reflex assessment, combined with the interview process, suggested that the average participant had 1.1 chronic infections (note that reflex assessment is not diagnostic [8]). 48.2% reported substantial symptomatic improvement (between 75% improvement to complete remission), whereas 49.7% reported minimal improvement (less than 75% improvement); total with any improvement was 97.9%. In the control group, the average control also had 1.1 chronic infections; 12.9% reported significant improvement, whereas 48.4% reported minimal improvement; total with any improvement was 61.3%. Improvement (from both groups) was reported for symptoms including bloating, diarrhea, constipation, flatulence, fecal incontinence, congestion, fatigue, lethargy, skin rashes, itching, abdominal pain, indigestion, and coughing. Analyzing the results utilizing Chi-square, comparing the two groups for total improvement and any improvement



revealed  $P < .0.1$  and  $P < 0.01$  respectively.

The improvement by possible infection type for the participants is shown below.

| Type.....      | %.....      | Substantially Improved..... | % Minimally Improved |
|----------------|-------------|-----------------------------|----------------------|
| Strep.....     | 2.8%.....   | 75.0%.....                  | 25.0%                |
| Staph.....     | 10.5% ..... | 60.0%.....                  | 33.3%                |
| Viral.....     | 21.7%.....  | 35.5%.....                  | 61.3%                |
| Fungal.....    | 33.6%.....  | 39.6%.....                  | 60.4%                |
| Parasitic..... | 42.7%.....  | 59.0%.....                  | 37.7%                |

The commercial zapping model seemed to require more repeated sessions than the engineered model to get similar results: this could be because the engineered model was designed differently (with an extra circuit) and/or because it was held by the participants longer. When long-term staphylococcus infections were present that did not clear-up with conventional antibiotic treatments, the engineered model seemed to be substantially more effective than the commercial model. 97.9% of participants reported symptomatic improvement; with 97.4% zapped with the commercial model and 98.4% with the engineered model (both combined with supplementation) reporting improvement. Neither age nor gender were found to have any significant impact on improvement.

Temporary (lasting less than one hour) adverse reactions to zapping, specifically dizziness or a near intoxicating feeling, were noted from three (2.1%) of the participants; all of which stated that benefits associated with the zapper exceeded the temporal adverse reactions. (A recent monograph by Dr. Robert Beck regarding the use of a similar device states "if subjects ever feel sleepy, sluggish, listless, bloated or headachy, or have flu-like reactions, they may be neglecting sufficient water intake" [16]. Dr. Clark advises that those who are pregnant or wearing a pacemaker should not use a zapping unit [2]) A more commonly heard comment was that some participants (5.1%) felt refreshed or relaxed after undergoing the zapping sessions. Temporary adverse reactions to supplementation included increased itching (in subjects who had previously complained of itching), increase of various reported symptoms, and mild intestinal discomfort: these complaints were only temporary when they occurred (generally less than one week).

## **DISCUSSION**

This trial did not include anyone who completely responded to previous nutrition-only interventions. My previous research has clearly shown that nutritional interventions can, on their own, result in symptomatic improvement when chronic infections are present [14,15]. This trial attempted to see if adding the intervention of bioelectrical stimulation could result in symptomatic improvement to greater degrees for people with chronic infections. Many of the participants were greatly impressed by the effectiveness of the zapper; some who improved,

however, felt the zapper had no effect and improvement was entirely due to the continued use of supplementation.

Although most understand that bacterial and viral infections are common [1-4], many health practitioners do not seem to understand that yeast/fungal infections and parasites are often found in humans [17,18]. Although one major study found parasites in 20.1% of stool samples [18], many of these parasites appear to not always cause detectable symptoms [1]. In humans, most parasites are believed to live within the digestive tract [1,18] (though Dr. Clark has implied that this may not be the case [2]). Parasites, by nature, must be able to live in an organism for a long-time without killing the host organism or getting killed by it [19]. Thus, it is not surprising that the highest percentage of the participants had this type of infection.

How does zapping work? Dr. Clark has written, "Any positively offset frequency kills all bacteria, viruses and parasites simultaneously given sufficient voltage (5 to 10 volts), duration (seven minutes), and frequency (anything from 10 Hz to 500,000 Hz)" [2]. A positive offset frequency is one which alternates between positive and zero voltage. I am not at all certain that zapping actually kills any invading microorganism. This trial suggests that since only 48.3% improved substantially, zapping probably did not kill "all bacteria, viruses and parasites" (according to Dr. Clark's book, the reason could be that possibly the current did not access all body regions, specifically the bowel contents [2]).

There are several reasons to believe that there may be scientific justification for the use of zappers. First, it needs to be understood that precisely how the body combats parasitic infections is not fully known [20]; this may be because many of the disease causing parasites have the ability to turn off immune responses [20]. (Both immune and non-immune responses are involved in the body's defenses against pathogens of all types [20].) It is possible that the body produces additional acid, has an IgG response [1,21], or has other actions to deal with intestinal parasites [20]. Second, it needs to be understood that both the colon and the small intestine produce electrical spike bursts [22]. Third, animal studies support the hypothesis that electrical stimulation has various effects on the body, including the inactivation of muscle acetyl CoA carboxylase and increasing AMP-activated protein kinase [23]. The inactivation of muscle acetyl CoA carboxylase may temporarily increase pyruvic acid [24] or decrease the effectiveness of normal portions of the immune system [25]. It has been reported that researchers from the Albert Einstein College of Medicine found that passing a current of only 50 microamps can prevent certain viruses (including HIV) from replicating [26]. It is of interest to note that a technique recently developed at the Royal London Hospital uses gracilis muscle augmentation combined with electrical stimulation to improve sphincter control in individuals with fecal incontinence [27] (some of the subjects in this trial had this symptom).

It may be possible that some of the body's defense mechanisms against

pathogens include electrical activity or that electrical activity may improve nutrient absorption. This last hypothesis is consistent with work performed by Dr. J.C. Weaver. Dr. Weaver performed a study in which he found that electrical stimulation appeared to make the body's cell walls more permeable so that its response to infection after ingesting supplemental nutrients was enhanced [28]. It is also consistent with a similar hypothesis written in 1924 by Dr. E.W. Cordingley that electrotherapy increases local nutrition [29].

Why does a subject undergo three zappings? Dr. Clark and this investigator have different opinions. Dr. Clark has written that the first zapping kills viruses, bacteria, and parasites. But a few minutes later, bacteria and viruses (different ones) often recur. I conclude they had been infecting the parasites, and killing the parasites released them. The second zapping kills the released viruses and bacteria, but soon a few viruses appear again. They must have been infecting some of the last bacteria. After a third zapping, I never find any viruses, bacteria, or parasite, even hours later [2]. This investigator does not agree, however, because often the same infection remains. It appears that repeated zappings are needed because it takes that long for the proper portion of the immune system to be properly stimulated into action. And I should add, for some people it only seems to be needed one or two times (some many more).

There are at least 130 different parasites [2,17], many different bacteria and viruses [4-7], and at least 150 medically significant yeast/fungi (*Candida albicans* is only 1 of them) [17,30]. Is the solution to the multiple infectious agents, as has been proposed by some [6], new antibiotics? With deadly infections that do not respond to drug-based treatments [4-7], should not other avenues be explored? The results of this study suggest that zapping combined with nutritional interventions may have helped most of the participants improve. Nutritional interventions give the body substances which it can use to improve immune responses [18]. Although this is not certain, it appears that either nutrient absorption is somehow improved [28,29] or IgG (immunoglobulin G) [1,19], some T cell (T-lymphocyte), biochemical acid, or some other defense mechanism is somehow stimulated through zapping and thus some segment of the immune system, but not the zapper, destroys the invader. Regardless of which (or whose) hypothesis is correct, it can be concluded that zapping and nutritional interventions can be helpful adjuncts for people with various forms of chronic infection and does deserve additional study.

## REFERENCES

- [1] Targan S, Shanahan F 1990 Immunology and Immunopathology of the Liver and Gastrointestinal Tract. Igaku-Shoin Medical Publishers, New York.
- [2] Clark H 1995 The Cure for All Diseases. New Century Press, San Diego.
- [3] Lorbor B. Changing patterns of infectious disease revisited. Am J Phar 1991; 1163:5-17.
- [4] Nugent S. New viruses in the jungle. ANMA Update 1995; 1 (2): 1

- [5] Norby SR. Antibiotic resistance: A self-inflicted problem. *J Int Med* 1996; 239:373-375.
- [6] Bradley J, Scheld W. The challenge of penicillin-resistant *Streptococcus pneumoniae* meningitis: current antibiotic therapy in the 1990s. *Clin Inf Dis* 1997; 24 (Sup.2):S213-S221.
- [7] Supergerm resists antibiotics. *The Good News* 1997; 2 (5):13.
- [8] Thiel RJ 1995 *Serious Nutrition for Health Care Professionals*. California Health Group, Arroyo Grande (CA).
- [9] Dr. Detox Circa 1987 *The Scalartronix: Rife Generator Operations Manual and Training Program*. San Diego.
- [10] Card #36 Shock Machine at Ripleys Odditorium, Hollywood, California (Specifically Identified as Electric Magneto Machine).
- [11] Beck R March 16, 1996 Experimental in vivo blood clearing device for eliminating viruses pathogens, microbes, bacteria, fungi, and parasites. Robert Beck, Santa Ana.
- [12] Miller T. Building the bioelectrifier: Can you heal yourself and take a poke at the medical establishment at the same time? *Amateur Radio Today*, May 1997:13-19.
- [13] Thiel R. Natural interventions for systemic mycoses. *JANA*, in review 1998.
- [14] Thiel RJ. Nutrition to improve the CD4 count of persons with AIDS. National Institutes of Health, Bethesda. April 1997:Submittal NTN B1.
- [15] Thiel RJ. Chronic fatigue assessment and intervention. *ANMA & AANC J* 1996; 1 (3):17-19.
- [16] Beck R March 20, 1997 Expanded instructions for experimental/theoretical blood electrification. Robert Beck, Santa Ana.
- [17] Chandler FW, Watts JC 1990 Mycotic, actinomycotic, and algal infections. In *Anderson's Pathology*, 9th ed., Mosby, St. Louis, pp. 391-432.
- [18] Results of testing for intestinal parasites by state diagnostic laboratories, United States, 1987. *Morbidity and Mortality Weekly* 1992; 40 (SS4):25-30.
- [19] Frank SA. Models of parasite virulence. *Qtr Rev Bio* 1996; 71 (1):37-78.
- [20] Keusch G 1994 Nutrition and Infection. In *Modern Nutrition in Health and Disease*, 8th ed.. Lea & Febiger, Philadelphia, pp. 1241-1258.
- [21] Akue JP, et al. High levels of parasite-specific IgG1 correlate with the amicrofilaremic state in *Loa loa* infection. *J Inf Dis* 1997; 175 (1):158-163.
- [22] Medeiros JA, Pontes FA, Mesquita OA. Is colonic electrical activity a similar phenomena to small-bowel electrical activity? *Dis. Colon Rectum* 1997; 40 (1):93-99.
- [23] Hutber CA, Hardie DG, Winder WW. Electrical stimulation inactivates muscle acetyl-CoA carboxylase and increases AMP-activated protein kinase. *Am J Phys* 1997; (2pt1):E262-E266.
- [24] Sidransky H 1990 Malnutrition and Deficiency Diseases. In *Anderson's Pathology*, 9th ed. Mosby, St. Louis, pp. 546-565.
- [25] Dakshinamurti K 1994 Biotin. In *Modern Nutrition in Health and Disease*, 8th ed. Lea & Febiger, Philadelphia, pp. 426-448.
- [26] Shocking treatment proposed for AIDS. *Science News*, March 30, 1991:207.
- [27] Stuchfield B. The electrically stimulated neoanal sphincter and colonic

conduit. Brit J Nurs 1997; 6 (4):219-224.

[28] Weaver JC. Electroporation: A general phenomenon for manipulation of cells and tissue. J Cell Bio 1993; 51:426-435.

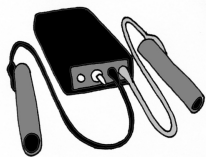
[29] Cordingley EW 1924 (Reprint 1971) Principles and Practices of Naturopathy. Health Research, Mokelumne Hill (CA), pp. 12-14.

[30] Larone DH 1993 Medically Important Fungi, 2nd ed. American Society of Microbiology, Washington.

The Center for Natural Health Research supplies research and other items for health care professionals interested in natural interventions.

For additional information check out <http://www.healthresearch.com>. This research is for doctors and other health care professionals. Thiel is not a medical doctor. None of this research is medical advice, nor should it be construed as medical advice; nor is any of this information specific for any individual.

Copyright 1999/2000 by Robert Thiel, Ph.D., Naturopath All rights reserved.



## ***Medical Applications of Electromagnetic Fields***

From: <http://adsabs.harvard.edu/abs/2010E&ES...10a2006L>

Authors: Lai, Henry C.; Singh, Narendra P.

Affiliation: AA(Department of Bioengineering, University of Washington, Seattle, WA 98195-5061, USA), AB(Department of Bioengineering, University of Washington, Seattle, WA 98195-5061, USA)

Publication: IOP Conference Series: Earth and Environmental Science, Volume 10, Issue 1, pp. 012006, 7 pp. (2010).

Publication Date: 04/2010

Origin: IOP

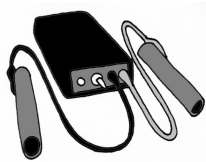
DOI: 10.1088/1755-1315/10/1/012006

Bibliographic Code: 2010E&ES...10a2006L

### **Abstract**

In this article, we describe two possible applications of low-intensity non-ionizing

electromagnetic fields (EMF) for the treatment of malaria and cancer, respectively. In malaria treatment, a low-intensity extremely-low frequency magnetic field can be used to induce vibration of hemozoin, a super-paramagnetic polymer particle, inside malaria parasites. This disturbance could cause free radical and mechanical damages leading to the death of the parasite. This concept has been tested in vitro on malaria parasites and found to be effective. This may provide a low cost effective treatment for malaria infection in humans. The rationale for cancer treatment using low-intensity EMF is based on two concepts that have been well established in the literature: (1) low-intensity non-thermal EMF enhances cytotoxic free radicals via the iron-mediated Fenton reaction; and (2) cancer cells have higher amounts of free iron, thus are more susceptible to the cytotoxic effects of EMF. Since normal cells contain minimal amount of free iron, the effect would be selectively targeting cancer cells. Thus, no adverse side effect would be expected as in traditional chemotherapy and radiation therapy. This concept has also been tested on human cancer cell and normal cells in vitro and proved to be feasible.



## ***Magnetic Fields May Hold Key to Malaria Treatment, UW Researchers Find***

From: <http://www.washington.edu/news/2000/03/30/magnetic-fields-may-hold-key-to-malaria-treatment-uw-researchers-find/>  
Rob Harrill March 30, 2000

A malaria parasite within a human red blood cell. The large circle in the parasite is a food vacuole. Stacked heme are visible inside the vacuole.

Researchers at the University of Washington have discovered a method of treating malaria with magnetic fields that could prove revolutionary in controlling the disease the World Health Organization calls one of the world's most complex and serious human health concerns.

Henry Lai, UW research professor of bioengineering, says the malaria parasite Plasmodium appears to lose vigor and can die when exposed to oscillating magnetic fields, which Lai thinks may cause tiny iron-containing particles inside the parasite to move in ways that damage the organism.

“If further studies confirm our findings and their application in animals and people, this would be an inexpensive and simple way to treat a disease that affects 500 million people every year, almost all in third-world countries,” Lai said. According to the World Health Organization, as many as 2.7 million people die of malaria every year. Approximately 1 million of those are children.

In the past two decades, the emergence of drug-resistant malaria parasites has created enormous problems in controlling the disease. Lai says his method could bypass those concerns because it is unlikely Plasmodium could develop a resistance to magnetic fields.

Malaria is spread by female Anopheles mosquitoes. The organism first invades the liver, then re-emerges into the bloodstream and attacks red blood cells. This is what causes malaria’s hallmark symptoms: fever, uncontrolled shivering, aches in the joints and headaches. Infected blood cells can block blood vessels to the brain, causing seizures and death. Other vital organs are also at risk.

Lai’s research appears to take advantage of how the parasites feed. Malaria parasites “eat” the hemoglobin in red blood cells of the host. They break down the globin portion of the hemoglobin molecule, but the iron portion, or the heme, is left intact because the parasite lacks the enzyme needed to degrade it. This causes a problem for the parasite because free heme molecules can cause a chain reaction of oxidation of unsaturated fatty acids, leading to membrane damage in the parasite. The malaria organism renders the free heme molecules non-toxic by binding them into long stacks – like “tiny bar magnets,” according to Lai.

He and three other researchers have exposed Plasmodium falciparum, the deadliest of the four malaria parasite species, to a weak alternating, or oscillating, magnetic field. Data sets showed that exposed samples ended up with 33 to 70 percent fewer parasites than unexposed samples. Measurements of hypoxanthine, a precursor for nucleic acid synthesis used by the parasite, indicated that metabolic activities had also significantly slowed in exposed samples. Such reductions would be enough to manage malaria, Lai said.

The oscillating magnetic field may affect the parasites in two ways, according to Lai. In organisms still in the process of binding free heme molecules into stacks, the alternating field likely “shakes” the stacked heme molecules, preventing further stacking. That would allow harmful heme free reign within the parasite. If the parasite is further along in its life cycle and has already bound the heme into stacks, the oscillating field could cause the stacks to spin, causing damage and death of the parasite.

Although initially promising, Lai says more research is needed.

“We need to make certain that it won’t harm the host,” Lai said. “My guess is that it won’t. It’s a very weak magnetic field, just a little stronger than the earth’s. The

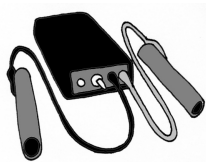
difference is that it is oscillating.”

If the method is proven effective and safe, Lai envisions rooms equipped with magnetic coils to produce the oscillating field.

“It would be very easy. People could come to the room and sit and read or whatever while they’re being treated,” he said. “Or you could set it up in the back of a big transport truck, then drive from village to village to treat people.”

Collaborating researchers include Jean E. Feagin, UW associate professor of pathobiology and senior scientist at the Seattle Biomedical Research Institute; and Ceon Ramon, UW electrical engineering research scientist.

For more information, contact Lai at (206) 543-1071 or hlai@u.washington.edu. Copies of a background symposium paper on the research are available via fax from Rob Harrill at (206) 543-2580 or rharrill@u.washington.edu. A high-resolution image of the malaria parasite is available on the Web at: <http://www.washington.edu/newsroom/news/images/malariacell.jpg>.



## ***Amplitude-Modulated Electromagnetic Fields for the Treatment of Cancer: Discovery of Tumor-Specific Frequencies and Assessment of a Novel Therapeutic Approach.***

From: <http://www.ncbi.nlm.nih.gov/pubmed/19366446>  
J Exp Clin Cancer Res. 2009 Apr 14;28:51. doi: 10.1186/1756-9966-28-51.  
Barbault A1, Costa FP, Bottger B, Munden RF, Bomholt F, Kuster N, Pasche B.

### **Abstract**

#### **PURPOSE:**

Because in vitro studies suggest that low levels of electromagnetic fields may modify cancer cell growth, we hypothesized that systemic delivery of a combination of tumor-specific frequencies may have a therapeutic effect. We undertook this study to identify tumor-specific frequencies and test the feasibility of administering such frequencies to patients with advanced cancer.

#### **PATIENTS AND METHODS:**



We examined patients with various types of cancer using a noninvasive biofeedback method to identify tumor-specific frequencies. We offered compassionate treatment to some patients with advanced cancer and limited therapeutic options.

#### RESULTS:

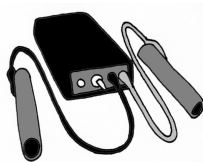
We examined a total of 163 patients with a diagnosis of cancer and identified a total of 1524 frequencies ranging from 0.1 Hz to 114 kHz. Most frequencies (57-92%) were specific for a single tumor type. Compassionate treatment with tumor-specific frequencies was offered to 28 patients. Three patients experienced grade 1 fatigue during or immediately after treatment. There were no NCI grade 2, 3 or 4 toxicities. Thirteen patients were evaluable for response. One patient with hormone-refractory breast cancer metastatic to the adrenal gland and bones had a complete response lasting 11 months. One patient with hormone-refractory breast cancer metastatic to liver and bones had a partial response lasting 13.5 months. Four patients had stable disease lasting for +34.1 months (thyroid cancer metastatic to lung), 5.1 months (non-small cell lung cancer), 4.1 months (pancreatic cancer metastatic to liver) and 4.0 months (leiomyosarcoma metastatic to liver).

#### CONCLUSION:

Cancer-related frequencies appear to be tumor-specific and treatment with tumor-specific frequencies is feasible, well tolerated and may have biological efficacy in patients with advanced cancer.

#### TRIAL REGISTRATION:

clinicaltrials.gov identifier NCT00805337.



## ***New Way to Kill Viruses: Shake Them to Death***

Michael Schirber | February 05, 2008 04:27am ET

From: <http://www.livescience.com/7472-kill-viruses-shake-death.html>

Three-dimensional model of an HIV virus.

Credit: 3DScience.com

Scientists may one day be able to destroy viruses in the same way that opera singers presumably shatter wine glasses. New research mathematically determined the frequencies at which simple viruses could be shaken to death.

"The capsid of a virus is something like the shell of a turtle," said physicist Otto Sankey of Arizona State University. "If the shell can be compromised [by mechanical vibrations], the virus can be inactivated."

Recent experimental evidence has shown that laser pulses tuned to the right frequency can kill certain viruses. However, locating these so-called resonant frequencies is a bit of trial and error.

"Experiments must just try a wide variety of conditions and hope that conditions are found that can lead to success," Sankey told LiveScience.

To expedite this search, Sankey and his student Eric Dykeman have developed a way to calculate the vibrational motion of every atom in a virus shell. From this, they can determine the lowest resonant frequencies.

As an example of their technique, the team modeled the satellite tobacco necrosis virus and found this small virus resonates strongly around 60 Gigahertz (where one Gigahertz is a billion cycles per second), as reported in the Jan. 14 issue of Physical Review Letters.

A virus' death knell

All objects have resonant frequencies at which they naturally oscillate. Pluck a guitar string and it will vibrate at a resonant frequency.

But resonating can get out of control. A famous example is the Tacoma Narrows Bridge, which warped and finally collapsed in 1940 due to a wind that rocked the bridge back and forth at one of its resonant frequencies.

Viruses are susceptible to the same kind of mechanical excitation. An experimental group led by K. T. Tsen from Arizona State University have recently shown that pulses of laser light can induce destructive vibrations in virus shells.

"The idea is that the time that the pulse is on is about a quarter of a period of a vibration," Sankey said. "Like pushing a child on a swing from rest, one impulsive push gets the virus shaking."

It is difficult to calculate what sort of push will kill a virus, since there can be millions of atoms in its shell structure. A direct computation of each atom's movements would take several hundred thousand Gigabytes of computer memory, Sankey explained.

He and Dykeman have found a method to calculate the resonant frequencies with much less memory.

In practice

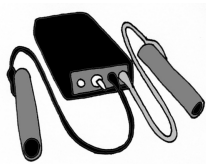
The team plans to use their technique to study other, more complicated viruses. However, it is still a long way from using this to neutralize the viruses in infected people.

One challenge is that laser light cannot penetrate the skin very deeply. But Sankey imagines that a patient might be hooked up to a dialysis-like machine that cycles blood through a tube where it can be hit with a laser. Or perhaps, ultrasound can be used instead of lasers.

These treatments would presumably be safer for patients than many antiviral drugs that can have terrible side-effects. Normal cells should not be affected by the virus-killing lasers or sound waves because they have resonant frequencies much lower than those of viruses, Sankey said.

Moreover, it is unlikely that viruses will develop resistance to mechanical shaking, as they do to drugs.

"This is such a new field, and there are so few experiments, that the science has not yet had sufficient time to prove itself," Sankey said. "We remain hopeful but remain skeptical at the same time."



## ***Kinetics of Microbial Inactivation for Alternative Food Processing Technologies -- Oscillating Magnetic Fields***

From: <http://www.fda.gov/Food/FoodScienceResearch/SafePracticesforFoodProcesses/ucm103131.htm>

### Scope of Deliverables

This section reports the effects of magnetic fields on microbial populations. Mechanisms of inactivation and critical process factors are described. Results of microbial testing experiments are controversial. Consistent results concerning the efficacy of this method are needed before its potential use as a food preservation method is assessed.

## 1. Definition, Description and Applications

Static (SMF) and oscillating (OMF) magnetic fields have been explored for their potential as microbial inactivation methods. For SMF, the magnetic field intensity is constant with time, while an OMF is applied in the form of constant amplitude or decaying amplitude sinusoidal waves. The magnetic field may be homogeneous or heterogeneous. In a homogeneous magnetic field, the field intensity  $B$  is uniform in the area enclosed by the magnetic field coil, while in a heterogeneous field,  $B$  is nonuniform, with the intensities decreasing as distances from the center of the coil increases. OMF applied in the form of pulses reverses the charge for each pulse, and the intensity of each pulse decreases with time to about 10% of the initial intensity (Pothakamury and others 1993).

Preservation of foods with OMF involves sealing food in a plastic bag and subjecting it to 1 to 100 pulses in an OMF with a frequency between 5 to 500 kHz at temperatures in the range of 0 to 50 °C for a total exposure time ranging from 25 to 100 ms. Frequencies higher than 500 kHz are less effective for microbial inactivation and tend to heat the food material (Barbosa-Cánovas and others 1998). Magnetic field treatments are carried out at atmospheric pressure and at moderate temperatures. The temperature of the food increases 2-5 °C. According to Hoffman (1985) exposure to magnetic fields causes inhibition in the growth and reproduction of microorganisms. OMF of intensity of 5 to 50 Tesla (T) and frequency of 5 to 500 kHz was applied and reduced the number of microorganisms by at least 2-log cycles. Within the magnetic field of 5-50 T, the amount of energy per oscillation coupled to 1 dipole in the DNA is  $10^{-2}$  to  $10^{-3}$  eV (Hoffman 1985). OMF of this intensity can be generated using: (1) superconducting coils; (2) coils which produce DC fields; or (3) coils energized by the discharge of energy stored in a capacitor (Gersdorf and others 1983). Inhibition or stimulation of the growth of microorganisms exposed to magnetic fields may be a result of the magnetic fields themselves or the induced electric fields. The latter is measured in terms of induced electric field strength and induced current density. To differentiate between electric field and magnetic field effects, a cylindrical enclosure containing cells and a medium that can be adapted to in vitro studies employing uniform, single-phase, extremely low frequency (ELF) magnetic fields is recommended.

## 2. Inactivation of Microorganisms

Yoshimura (1989) classified the effects of magnetic fields on microbial growth and reproduction as (1) inhibitory, (2) stimulatory and (3) none observable. Pothakamury and others (1993) summarized the effect of magnetic fields on microorganisms as shown in Table 1.

Table 1. Effect of magnetic fields on microorganisms.

| <b>Microorganism</b>         | <b>Type of Magnetic field</b> | <b>Field Strength (T)</b> | <b>Frequency of pulse (Hz)</b> | <b>Effect</b>  | <b>Reference</b>            |
|------------------------------|-------------------------------|---------------------------|--------------------------------|--|-----------------------------|
| Wine yeast cell              | Heterogeneous Magnetic field  | 0.04                      | 0                              | Growth inhibited when exposed for 5, 20, 25, 60, 120, or 150 min; no inhibition for 10, 15, 17 min exposure  | Kimball (1937)              |
| Wine yeast cell              | Heterogeneous Magnetic field  | 1.1                       | 0                              | No effect for 5, 10, 20, 40 or 80 min exposure   | Kimball (1937)              |
| <i>Serratia marcescens</i>   | Heterogeneous Magnetic field  | 1.5                       | -                              | Growth rate remains same as in controls up to 6 h; growth rate decreases between 6 and 7 h and again increases between 8 and 10 h; at 10 h cell population same as in controls | Gerenscer and others (1962) |
| <i>Staphylococcus aureus</i> | Heterogeneous Magnetic field  | 1.5                       | 0                              | Growth rate increases between 3 and 6 h; then decreases  | Gerenscer and others (1962) |

|   |                               |                       |                     |  |                               |
|---|-------------------------------|-----------------------|---------------------|--|-------------------------------|
|   |                               |                       |                     | between 6 and 7 h; cell population at 7 h is same as controls      |                               |
| Saccharomyces cerevisiae                  | Heterogeneous Smagnetic field | 0.465                 | 0                   | Rate of reproduction reduced, incubated for 24, 48 or 72 h         | Van Nostrand and others(1967) |
| Escherichia coli                          | Smagnetic field               | 0.3                   | 0                   | Growth simulated   | Moore (1979)                  |
| Halobacterium halobium, Bacillus subtilis | Smagnetic field               | 0.015<br>0.03<br>0.06 | 0                   | Growth inhibited   | Moore (1979)                  |
| Pseudomonas aeruginosa, Candida albicans  | Omagnetic field               | 0.015<br>0.03<br>0.06 | 0.1-0.3             | Growth simulated; stimulation increases with increase in frequency | Moore (1979)                  |
| E. coli                                   | Omagnetic field               | 0.15                  | 0.05                | Inactivation of cells when concentration was 100 cells/mL          | Moore (1979)                  |
| Streptococcus thermophilus in milk        | Omagnetic field               | 12.0                  | 6,000 (1 pulse)     | Cell population reduced from 25,000 cells/ml to 970                | Moore (1979)                  |
| Saccharomyces in yogurt                   | Omagnetic field               | 40.0                  | 416,000 (10 pulses) | Cell population reduced from 3,500 cells/ml to 25                  | Hofmann (1985)                |

|                               |                  |      |                   |   |                                |
|-------------------------------|------------------|------|-------------------|---|--------------------------------|
| Saccharomyces in orange juice | O magnetic field | 40.0 | 416,000 (1 pulse) | Cell population reduced from 25,000 cells/ml to 6   | Hofmann (1985)                 |
| Mold spores                   | O magnetic field | 7.5  | 8,500 (1 pulse)   | Population reduced from 3,000 spores/ml to 1  | Hofmann (1985)                 |
| Saccharomyces cerevisiae      | S magnetic field | 0.56 | 0                 | Decreased growth rate; interaction between temperature and magnetic field only during the logarithmic phase | Van Nostrand and others (1967) |

aSmagnetic field = static magnetic field; Omagnetic field = oscillating magnetic field

Hoffman (1985) reported on the inactivation of microorganisms with OMF in milk, yogurt, orange juice, and bread roll dough. According to Hoffman (1985) only 1 pulse of OMF was adequate to reduce the bacterial population between  $10^2$  and  $10^3$  cfu/g. The intensity of the magnetic field required to achieve these effects varied between 2-25 T and a frequency range from 5-500 Hz.

A review of the literature shows that inconsistent results have been obtained on the effect of OMF on microbial growth (Table 1). In some cases OMF stimulated or inhibited microbial growth and, in others, it had no effect on microbial growth. The results presented in Table 1 show that, although not well understood, the effect of magnetic fields on the microbial population of foods may depend on the magnetic field intensity, number of pulses, frequency and property of the food (that is, resistivity, electrical conductivity, and thickness of the foodstuff).

### 3. Mechanisms of Microbial Inactivation

SMF or OMF may have some potential to inactivate microorganisms in food. Pothakamury and others (1993) reported 2 theories to explain the inactivation mechanisms for cells placed in SMF or OMF. The first theory stated that a "weak" OMF could loosen the bonds between ions and proteins. Many proteins vital to the cell metabolism contain ions. In the presence of a steady background magnetic

field such as that of the earth, the biological effects of OMF are more pronounced around particular frequencies, the cyclotron resonance frequency of ions (Coughlan and Hall 1990).

An ion entering a magnetic field  $B$  at velocity  $v$  experiences a force  $F$  given by:

$$F = q \vec{v} \times \vec{B} \quad (1)$$

Figure 1 shows the movement of a charged particle in a magnetic field. When  $v$  and  $B$  are parallel,  $F$  is zero. When  $v$  is normal to  $B$ , the ion moves in a circular path ( Fig. 2). For other orientations between  $v$  and  $B$ , the ions move in a helical path ( Fig. 3). The frequency at which the ions revolve in the magnetic field is known as the ion's gyrofrequency  $\omega$ , which depends on the charge/mass ratio of the ion and the magnetic field intensity:

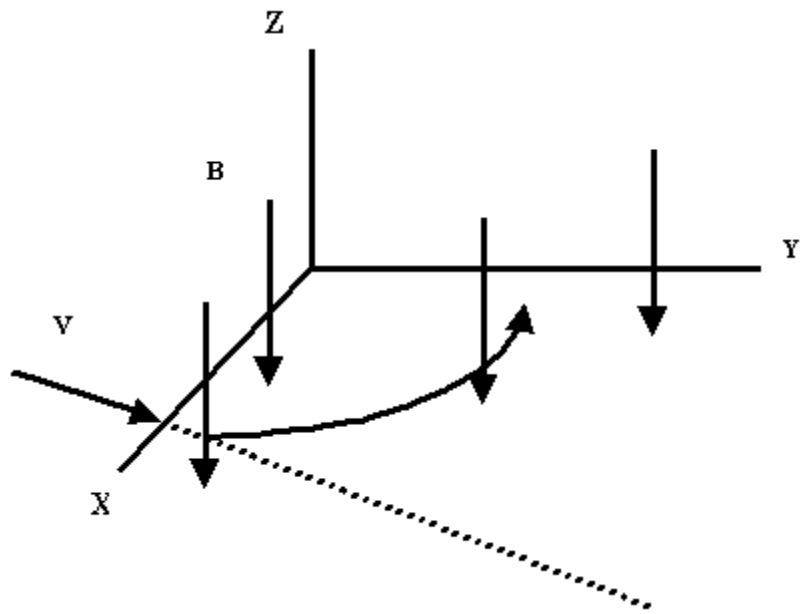
$$\omega = q B / (2 \pi m) \quad (2)$$

where  $q$  is the charge and  $m$  is the mass of the ion. Cyclotron resonance occurs when  $\omega$  is equal to the frequency of the magnetic field. At  $50 \mu T$ , the resonance frequency of  $Na^+$  and  $Ca^+$  is 33.33 and 38.7 Hz, respectively. At cyclotron resonance, energy is transferred selectively from the magnetic field to the ions with  $\omega$  equivalent to frequency of the magnetic field. The interaction site of the magnetic field is the ions in the cell, and they transmit the effects of magnetic fields from the interaction site to other cells, tissues, and organs.

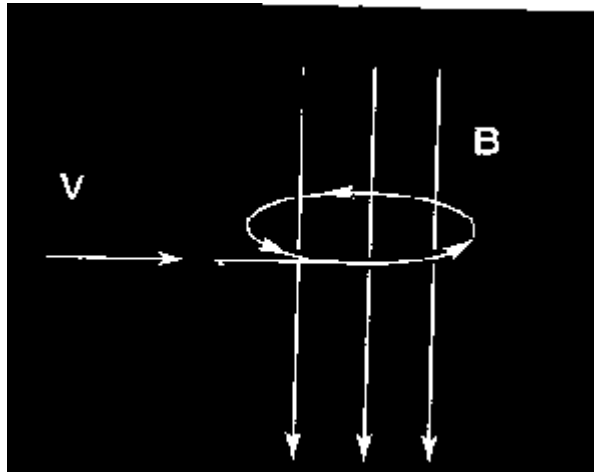
A second theory considers the effect of SMF and OMF on calcium ions bound in calcium-binding proteins, such as calmodulin. The calcium ions continually vibrate about an equilibrium position in the binding site of calmodulin. A steady magnetic field to calmodulin causes the plane of vibration to rotate, or proceed in the direction of magnetic field at a frequency that is exactly = of the cyclotron frequency of the bound calcium. Adding a "wobbling" magnetic field at the cyclotron frequency disturbs the precision to such an extent that it loosens the bond between the calcium ion and the calmodulin (Pothakamury and others 1993).

Hoffman (1985) suggested that the inactivation of microorganisms may be based on the theory that the OMF may couple energy into the magnetically active parts of large critical molecules such as DNA. Within 5-50 T range, the amount of energy per oscillation coupled to 1 dipole in the DNA is  $10^{-2}$  to  $10^{-3}$  eV. Several oscillations and collective assembly of enough local activation may result in the breakdown of covalent bonds in the DNA molecule and inhibition of the growth of microorganisms (Pothakamury and others 1993).

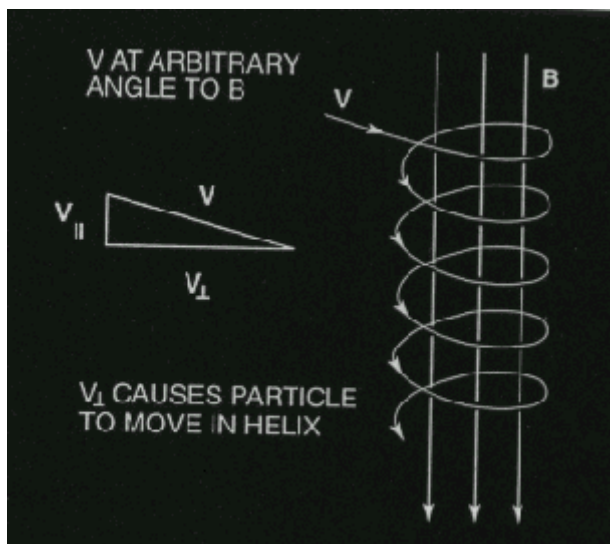




**Figure 1.** Charged particle in a magnetic field.

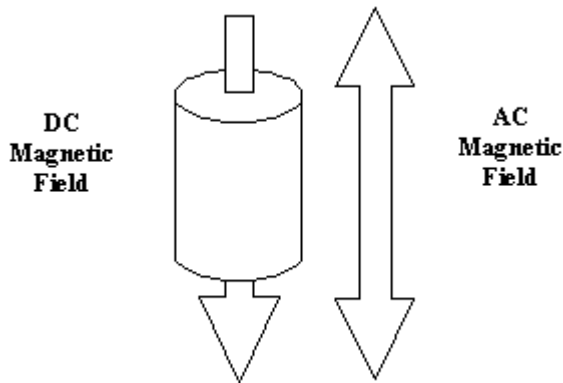


**Figure 2.** Charged particle in a magnetic field when  $v$  is normal to  $B$ .



**Figure 3.** Charged particle in a magnetic field when  $V$  makes an arbitrary angle with  $B$ .

The work of San-Martin and others (1999) shows that an externally applied electromagnetic signal at frequencies close to a given resonance and parallel to an SMF ( Fig. 4) may couple to the corresponding ionic species in such a way as to selectively transfer energy to these ions and thus indirectly to the metabolic activities in which they are involved. The earth's total field ranges from 25 to 70  $\mu$  T. Most of the slightly and double charged ions of biological interest have corresponding gyrofrequencies in the ELF range 10 to 100 Hz for this field strength.



**Figure 4.** Required AC and DC magnetic field orientation to achieve ion cyclotron.

#### 4. Validation/Critical Process Factors

The critical process factors affecting the inactivation of microbial populations by magnetic fields are not completely understood. Some factors believed to influence microbial inactivation include magnetic field intensity, electrical resistivity, and microbial growth stage.

##### 4.1. Magnetic Field

Exposure to a magnetic field may stimulate or inhibit the growth and reproduction of microorganisms. A single pulse of intensity of 5 to 50 T and frequency of 5 to 500 kHz generally reduces the number of microorganisms by at least 2-log cycles (Hoffman 1985). High intensity magnetic fields can affect membrane fluidity and other properties of cells (Frankel and Liburdy 1995). Inconsistent results of other inactivation studies (see Table 1), however, make it impossible to clearly state the microbial inactivation efficiency of magnetic field or to make any predictions about its effects on microbial populations.

##### 4.2. Electrical Resistivity

For microorganisms to be inactivated by OMF, foods need to have a high electrical resistivity (greater than 10 to 25 ohms-cm). The applied magnetic field intensity depends on the electrical resistivities and thickness of the food being magnetized,

with larger magnetic fields intensities used with products with large resistivity and thickness.

#### 4.3. Microbial Growth Stage

Tsuchiya and others (1996), working with homogeneous (7 T) and inhomogeneous (5.2 to 6.1 T and 3.2 to 6.7 T) magnetic fields, found a growth stage dependent response of *Escherichia coli* bacterial cultures. The ratio of cells under magnetic field to cells under geomagnetic field was less than 1 during the first 6 h of treatment and greater than 1 after 24 h. These authors also found that cell survival was greater under inhomogeneous compared with homogeneous fields. Based on the assumption that magnetic fields could act as a stress factor, cells collected after 30 min of incubation under magnetic field treatment (lag or early lag growth phase) or in the stationary phase after long-term magnetic field treatment were heated to 54 °C. No differences were observed between the treated and control samples. Little else is known about the effect of microbial growth stage on susceptibility to magnetic fields.

#### 5. Process Deviations

Data acquisition systems must be installed in the processing area to monitor and control the power source, number of pulses, and frequencies applied to the food. Food composition, temperature, size of unit, among other factors also would require control and monitoring to assure constant treatments. Any deviation from the specified conditions such as temperature changes must be continuously recorded and appropriate responses taken. If the system shuts down or fails to deliver the described treatment during processing, the food must be reprocessed to assure quality and safety.

#### 6. Research Needs

There is a significant lack of information on the ability of OMF treatment to inactivate pathogenic microorganisms and surrogates. A main area that needs to be elucidated is the confirmation that magnetic field treatment is an effective process to inactivate microbes. Once this is established, significant data gaps still must be closed before this technology can be safely and practically applied to food preservation. Some of the more significant research needs are:

- Identify key resistant pathogens.
- Establish the effects of magnetic fields on microbial inactivation.
- Elucidate the destruction kinetics of magnetic fields.
- Determine the mechanism of action of magnetic fields.
- Determine critical process factors and effects on microbial inactivation.
- Validate the process and evaluate indicator organisms and appropriate surrogates.
- Identify process deviations and determine ways to address them.

#### GLOSSARY

A complete list of definitions regarding all the technologies is located at the end of this document.

Cyclotron resonance. Phenomenon that occurs when the frequency of revolving ions induced by a specific magnetic field intensity is similar to the frequency of that magnetic field and parallel to it. In these instances, energy may be transferred to the ions, affecting cell metabolic activities.

Cyclotron. An accelerator in which particles move in spiral paths in a constant.

Dipole. For oscillating magnetic fields, a magnetic particle that contains a \*north\* and \*south\* magnetic pole.

Gyrofrequency. Frequency at which the ions revolve in a magnetic field.

Heterogeneous magnetic field. Magnetic field that exhibits a gradient depending on the nature of the magnet.

Homogeneous magnetic field. Magnetic field with a constant strength over space.

Magnetic flux density. Force that an electromagnetic source exerts on charged particles. Magnetic flux density is measured in Telsa (1 Telsa = 104 gauss).

Oscillating magnetic field. Fields generated with electromagnets of alternating current. The intensity varies periodically according to the frequency and type of wave in the magnet.

Sinusoidal Wave. A mode of propagation of the magnetic field.

Static magnetic field. Magnetic fields with a constant strength over time.

Telsa. Unit to express magnetic flux density (B). 1 Telsa (T) = 104 gauss.

## REFERENCES

Barbosa-Cánovas, G.V., Pothakamury, U.R., and Barry, G.S. 1994. State of the art technologies for the stabilization of foods by non-thermal processes: physical methods. In: Barbosa-Cánovas, G.V., and Welti-Chanes, J.(eds.), Food Preservation by Moisture control. Lancaster, Technomic Publishing.pp. 423-532.

Barbosa-Cánovas, G.V., Gongora-Nieto, M.M., and Swanson, B.G. 1998. Nonthermal electrical methods in food preservation. Food Sci. Int. 4(5):363-370.

Coughlan, A., Hall, N. 1990. How magnetic field can influence your ions? New Scientist. 8(4):30

Frankel, R. B. and Liburdy, R. P. 1995. Biological effects of static magnetic fields. In Handbook of Biological Effects of Electromagnetic Fields. Polk, C. and Postow, E. (Ed). 2<sup>nd</sup> Ed. CRC Press. Boca Raton, FL

Gerencser, V.F., Barnothy, M.F., and Barnothy, J.M. 1962. Inhibition of bacterial growth by magnetic fields. Nature, 196:539-541.

Gersdorf, R., deBoer, F.R., Wolfrat, J.C., Muller, F.A., Roeland, L.W. 1983. The high magnetic facility of the University of Amsterdam, high field magnetism. Proceedings International symposium on High Field Magnetism. Osaka, Japan. 277-287

Hofmann, G.A. 1985. Deactivation of microorganisms by an oscillating magnetic field. U.S. Patent 4,524,079.

Kimball, G.C. 1937. The growth of yeast on a magnetic fields. J. Bacteriol. 35:109-122.

Moore, R.L. 1979. Biological effects of magnetic fields. Studies with microorganisms. Can. J. Microbiol., 25:1145-1151.

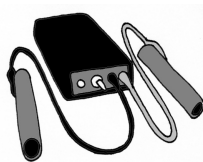
Pothakamury, U.R., Barbosa-Cánovas, G.V., and Swanson, B.G. (1993). Magnetic-field inactivation of microorganisms and generation of biological changes. Food Technol. 47(12):85-93.

San-Martin, M.F., Harte, F.M., Barbosa-Cánovas, G.V., and Swanson, B.G. 1999. Magnetic field as a potential non-thermal technology for the inactivation of microorganisms. Washington State University, Biological Systems Engineering, Pullman, WA., USA. (Unpublished).

Tsuchiya, K., Nakamura, K., Okuno, K., Ano, T. and Shoda, M. 1996. Effect of homogeneous and inhomogeneous high magnetic fields on the growth of *Escherichia coli*. J Ferment Bioeng 81(4):343-346.

Van Nostran, F.E., Reynolds, R.J. and Hedrick, H.G. 1967. Effects of a high magnetic field at different osmotic pressures and temperatures on multiplication of *Saccharomyces cerevisiae*. Appl Microbiol. 15: 561-563.

Yoshimura, N. 1989. Application of magnetic action for sterilization of food. Shokukin Kihatsu 24(3):46-48.



# Scientific Studies on Hulda Clark's Herbal Parasite Cleanse

Because Dr. Hulda Clark suggests to combine the [Herbal Parasite Cleanse](#) along with Zapping, we have included a few scientific studies on Dr. Clark's herbs.



Dr. Lai who conducted the first study in this chapter using a Hulda Clark Zapper (*Low-Intensity Electric Current-Induced Effects On Human Lymphocytes and Leukemia Cells*) also did studies involving the herbs found in Dr. Clark's *Herbal Parasite Cleanse*. **Wormwood** contains the compound: **artemisinin**. Here is Dr. Lai's study:

---

## ***Targeted Treatment Of Cancer With Artemisinin And Artemisinin-Tagged Iron-Carrying Compounds.***

From: <http://www.ncbi.nlm.nih.gov/pubmed/16185154>

Lai H1, Sasaki T, Singh NP.

Abstract

Artemisinin is a chemical compound that reacts with iron to form free radicals which can kill cells. Cancer cells require and uptake a large amount of iron to proliferate. They are more susceptible to the cytotoxic effect of artemisinin than normal cells. Cancer cells express a large concentration of cell surface transferrin receptors that facilitate uptake of the plasma iron-carrying protein transferrin via endocytosis. By covalently tagging artemisinin to transferrin, artemisinin could be selectively picked up and concentrated by cancer cells. Furthermore, both artemisinin and iron would be transported into the cell in one package. Once an artemisinin-tagged transferrin molecule is endocytosed, iron is released and reacts with artemisinin moieties tagged to transferrin. Formation of free radicals kills the cancer cell. The authors have found that artemisinin-tagged transferrin is highly selective and potent in killing cancer cells. Thus, artemisinin and artemisinin-tagged iron-carrying compounds could be developed into powerful anticancer drugs.



Here are a few more studies involving ingredients found in Dr. Hulda Clark's *Herbal Parasite Cleanse*. **Black Walnut Hull** contains **juglone**. Here are several studies on juglone:

## ***Anticancer Activity And Mechanism Of Juglone On Human Cervical Carcinoma HeLa Cells.***

From: <http://www.ncbi.nlm.nih.gov/pubmed/23181283>

Zhang W1, Liu A, Li Y, Zhao X, Lv S, Zhu W, Jin Y.

### Abstract

Induction of apoptosis in tumor cells has become the major focus of anti-tumor therapeutics development. Juglone, a major chemical constituent of *Juglans mandshurica* Maxim, possesses several bioactivities, including anti-tumor. In the present study, HeLa cells were incubated with juglone at various concentrations. The proliferation inhibition of juglone on HeLa cells was tested by the MTT assay. Occurrence of apoptosis was detected by Hoechst 33258 staining, flow cytometry, and transmission electron microscopy. The expression of apoptotic-related proteins was examined by Western blot. The results showed that juglone inhibits the growth of HeLa cells in dose-dependent manner. Topical morphological changes of apoptotic body formation after juglone treatment were observed. The

percentages of early apoptosis of Annexin V-FITC were 5.23%, 7.95%, 10.69%, and 20.92% with the concentrations of juglone (12.5, 25, 50, and 100  $\mu\text{mol/L}$ ), respectively. After cells were treated with juglone at the different dose for 24 h, the expression of Bcl-2 was significantly down-regulated and the expression of Bax was significantly up-regulated compared with the control. These events paralleled with activation of caspase-9, -8, -3, and PARP cleavage. The results suggest that juglone may be effective for the treatment of HeLa cells.



## ***Anti-Proliferative Effect Of Juglone From Juglans Mandshurica Maxim On Human Leukemia Cell HL-60 By Inducing Apoptosis Through The Mitochondria-Dependent Pathway.***

From: <http://www.ncbi.nlm.nih.gov/pubmed/20655907?report=abstract>

Xu HL1, Yu XF, Qu SC, Zhang R, Qu XR, Chen YP, Ma XY, Sui DY.

### **Abstract**

Induction of apoptosis in tumor cells has become the major focus of anti-tumor therapeutics development. Juglone, a major chemical constituent of *Juglans mandshurica Maxim*, possesses several bioactivities including anti-tumor. Here, for the first time, we studied the molecular mechanism of Juglone-induced apoptosis in human leukemia HL-60 cells. In the present study, HL-60 cells were incubated with Juglone at various concentrations. Occurrence of apoptosis was detected by Hoechst 33342 staining and flow cytometry. Expression of Bcl-2 and Bax mRNA was determined by quantitative polymerase chain reaction (qPCR). The results showed that Juglone inhibits the growth of human leukemia HL-60 cells in dose- and time-dependent manner. Topical morphological changes of apoptotic body formation after Juglone treatment were observed by Hoechst 33342 staining. The percentages of Annexin V-FITC-positive/PI negative cells were 7.81%, 35.46%, 49.11% and 66.02% with the concentrations of Juglone (0, 0.5, 1.0 and 1.5 microg/ml). Juglone could induce the mitochondrial membrane potential ( $\Delta\psi_m$ ) loss, which preceded release of cytochrome c (Cyt c), Smac and apoptosis inducing factor (AIF) to cell cytoplasm. A marked increased of Bax



mRNA and protein appeared with Juglone treatment, while an evidently decreased of Bcl-2 mRNA and protein appeared at the same time. These events paralleled with activation of caspase-9, -3 and PARP cleavage. And the apoptosis induced by Juglone was blocked by z-LEHD-fmk, a caspase-9 inhibitor. Those results of our studies demonstrated that Juglone-induced mitochondrial dysfunction in HL-60 cells trigger events responsible for mitochondrial-dependent apoptosis pathways and the elevated ratio of Bax/Bcl-2 was also probably involved in this effect.



## ***Effect Of Juglone On The Ultrastructure Of Human Liver Cancer BEL-7402 Cells.***

From: <http://www.ncbi.nlm.nih.gov/pubmed/19726363>

Chen L1, Na-Shun BY, Zhang J, Yu J, Gu WW.

### **Abstract**

**OBJECTIVE:** To study the effect of juglone on the ultrastructure of human liver cancer BEL-7402 cells.

**METHODS:** BEL-7402 cells were incubated in the presence of 12.5 micromol/L juglone for 24 h, and fixed in 2.5% glutaraldehyde for HE staining and Coomassie brilliant blue staining and scanning electron microscopy.

**RESULTS:** Incubation with juglone resulted in obvious changes in the cell morphology and cytoskeletal alterations of the cells. Scanning electron microscopy revealed reduced volume of the cell bodies, dissociation of the cells, curling and malformation of the microvilli on the cell surface with rupture of the intercellular junction and enlargement of the intercellular space. The formation of apoptotic bodies was observed. Transmission electron microscopy showed expansion of the endoplasmic reticula, mitochondrial crista disintegration, nucleolar fragmentation and formation of the apoptotic bodies after the exposure to juglone for 24 h.

**CONCLUSION:** Juglone can cause ultrastructural changes of human liver cancer BEL-7402 cells and induce their apoptosis.

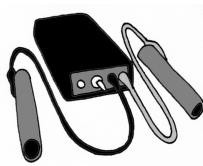
# ***Juglone, Isolated From Juglans Mandshurica Maxim, Induces Apoptosis Via Down-Regulation Of AR Expression In Human Prostate Cancer LNCaP Cells.***

From: <http://www.ncbi.nlm.nih.gov/pubmed/23643730>

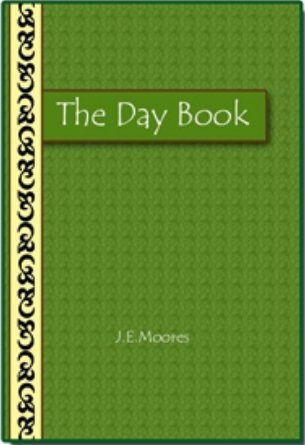
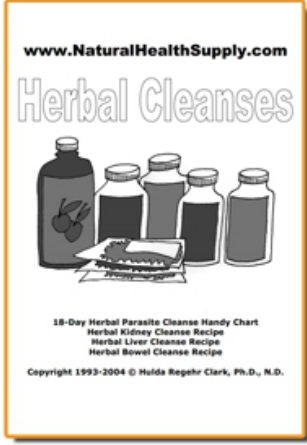
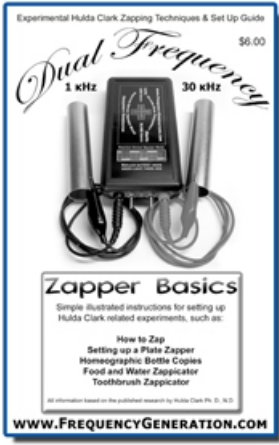
Xu H1, Yu X, Qu S, Sui D.

## **Abstract**

Juglone is a natural compound which has been isolated from *Juglans mandshurica* Maxim. Recent studies have shown that juglone had various pharmacological effects such as anti-viral, anti-bacterial and anti-cancer. However, its anti-cancer activity on human prostate cancer LNCaP cell has not been examined. Thus, the current study was designed to elucidate the molecular mechanism of apoptosis induced by juglone in androgen-sensitive prostate cancer LNCaP cells. MTT assay was performed to examine the anti-proliferative effect of juglone. Occurrence of apoptosis was detected by Hoechst 33342 staining and flow cytometry in LNCaP cells treated with juglone for 24h. The result shown that juglone inhibited the growth of LNCaP cells in a dose-dependent manner. Morphological changes of apoptotic body formation after juglone treatment were observed by Hoechst 33342 staining. This apoptotic induction was associated with loss of mitochondrial membrane potential, and caspase-3, -9 activation. Moreover, we found that juglone significantly inhibited the expression levels of androgen receptor (AR) and prostate-specific antigen (PSA) in a dose-dependent manner, as well as abrogated up-regulation of AR and PSA genes with and/or without dihydrotestosterone (DHT). Take together, our results demonstrated that juglone might induce the apoptosis in LNCaP cell via down-regulation of AR expression. Therefore, our results indicated that juglone may be a potential candidate of drug for androgen-sensitive prostate cancer.



# Other Free eBooks

| <b><i>The Day Book</i></b>  | <b><i>Herbal Cleanses</i></b>   | <b><i>Zapper Basics</i></b>   |
|---|---|---|
|  |  |  |

**Save a copy of these PDF books to your computer for future reference.**

***Frequency Generation brand Zappers are available at [HuldaClark.com](http://HuldaClark.com)***

**For Distributor information visit: [FrequencyGeneration.com](http://FrequencyGeneration.com)**



**For photos, videos, and more information visit:**

**[www.HuldaClark.com](http://www.HuldaClark.com)**